

electric*Q*

USER MANUAL

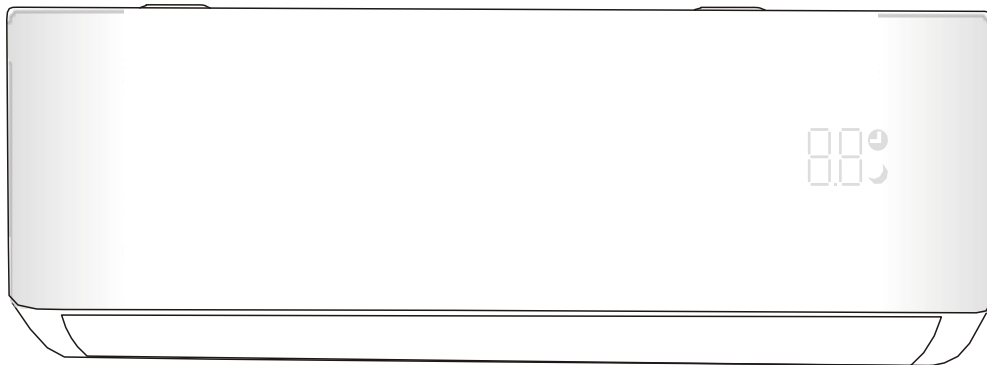

iQool28

28,000 BTU

SMART WiFi CONTROLLED WALL MOUNTED INVERTER SPLIT AIR CONDITIONER WITH HEAT PUMP

**Thank you for choosing an electricQ Air Conditioner
Please read this user manual before using this innovative
Air Conditioner and keep it safe for future reference.**

SETTLING IN OK?

We hope this has been helpful to you.

We would love to see how you're getting on with your new purchase, so please share any snaps you have on the platform of your choice below.

Our community awaits your uploads - Snap, tag and hashtag away!



@electriQUK
#electriQUK

WE'RE HERE TO HELP

Should you have any problems or questions with your purchase, please contact a member of our customer service team.

☎ 0330 390 3061

✉ support@electriQ.co.uk

Mon-Fri | 9am to 5pm

Unit 2A, Trident Business Park,
Neptune Way, Leeds Road,
Huddersfield, HD2 1UA

CONTENTS

SAFETY WARNINGS	4
ENERGY SAVING AND UNIT SAFETY PROTECTION TIPS	5
HOW SPLIT AIR CONDITIONERS WORK	6
SYSTEM DIAGRAM	7
PARTS LIST	8
INSTALLATION INFORMATION	9
HOW TO OPERATE YOUR AIR CONDITIONER	10
THE DISPLAY	10
EMERGENCY BUTTON	10
SETTING UP THE REMOTE	11
QUICK START GUIDE	12
REMOTE CONTROL	13
UNDERSTANDING THE FUNCTIONS	15
IMPORTANT INFORMATION	18
SETTING UP THE WiFi APP	19
USING THE WiFi APP	24
CLEANING AND MAINTENANCE	29
TROUBLESHOOTING AND SELF DIAGNOSIS	31
TECHNICAL SPECIFICATION	34
SUPPORT	35

SAFETY WARNINGS

IMPORTANT!

- Carefully read the instructions before operating the unit
- This appliance comprises of an indoor unit and an outdoor unit. The indoor slim evaporator is designed exclusively for indoor installations while the external condenser should be installed outside while still away from flood water or snow line.
- Always place the outdoor unit on a dry and stable surface. Install the outdoor unit on a wall with wall-mounting brackets or fix to a floor slab with special floor mounting slab bolts or brackets away from flood or snow lines.
- Rating: This unit must be only connected to a 220-240 V / 50 Hz earthed power source.
- Installation must be in accordance with the regulations of the country where the unit is used.
- This appliance is intended for permanent installation into a fixed structure, and should not be installed on vehicles.
- The outdoor part of the air conditioner unit must always be stored and transported upright, otherwise irreparable damage may be caused to the compressor; if in doubt we suggest waiting at least 24 hours before starting the unit.
- These air conditioners are supplied with pre-flared refrigeration pipes and electrical cables, which enables the installer to reduce the installation time.
- European Union regulations requires for an F-Gas trained engineer to handle any operation where non-qualified intervention could cause fluorinated gas to escape. A commissioning certificate must be issued with any installation.
- This air conditioner contains R32 which is a safe efficient refrigerant which has a lower environmental burden than traditional refrigerants.
- The refrigerant used in this air conditioner is an environmentally friendly hydrocarbon R32, which has a very low Global Warming Potential compared to traditional refrigerants.
- R32 is classed as slightly flammable and as such naked flames and sources of ignition should be kept a safe distance from the unit. If you are in any doubt about the suitability of your electrical supply have it checked and, if necessary, modified by a qualified electrician.
- This air conditioner has been tested and is safe to use. However, as with any electrical appliance - use it with care.
- Disconnect the power before dismantling, assembling or cleaning.
- Never connect the unit to an electrical outlet using an extension cord. Both the indoor unit and outdoor must be hardwired by a qualified electrician.
- Never operate this appliance if the cord is damaged. Ensure the power cord is not stretched or exposed to sharp objects or edges.
- A damaged supply cord should be replaced by the manufacturer or a qualified electrician in order to avoid a hazard.
- Avoid touching any moving parts within the appliance.
- Never insert fingers, pencils or any other objects through the guard.
- This appliance is not intended for use by persons (including children) with reduced physical, sensory or mental capabilities. It is also not intended for use by those with a lack of experience and knowledge, unless they have been given supervision or instruction concerning the use of the appliance by a person responsible for their safety. Do not leave children unsupervised with this appliance.
- Do not clean the unit by spraying it or immersing it in water.
- Any service other than regular cleaning or

SAFETY WARNINGS

- filter replacement should be performed by an authorised service representative or a qualified air conditioning engineer. Failure to comply could result in a voided warranty.
- This air conditioner is intended for cooling / heating a room to a suitable level for human comfort, and should not be used for any other purpose such as cooling food.
 - Avoid restarting the air conditioning unit unless 3 minutes have passed since being turned off. This prevents damage to the compressor.
 - Never use the mains as a switch to start and turn off the air conditioning unit. Use the provided ON/OFF button located on the remote control.
 - The indoor unit should not be installed in laundry or wet rooms.
 - Diagrams and pictures provided within the manual are for guidance only. Due to continual product development, if there is any variance between the manual and the product received, the information provided on the product should be followed.



CAUTION: RISK OF FIRE



READ THE OPERATING INSTRUCTIONS



READ THE TECHNICAL MANUAL

ENERGY SAVING AND UNIT SAFETY PROTECTION TIPS

- Do not cover or restrict the airflow from the outlet or inlet grills.
- For maximum performance the minimum distance from a wall or objects should be 50cm.
- Keep the filters clean. Under normal conditions, filters should only need cleaning once every four weeks (approximately). Since the filters remove airborne particles, more frequent cleaning maybe necessary, depending on the air quality.
- For the initial startup set the fan speed to maximum and the thermostat to 4-5 degrees lower than the current temperature. After, set the fan switch to low and set the thermostat to your desired setting.
- To protect the unit we recommend not using the cooling mode when the ambient indoor temperature is higher than 35°C.
- To protect the unit we recommend not using the heating mode when the indoor ambient temperature is lower than 7°C. Performance will be reduced at lower temperatures.
- Note the manufacturer operating temperature ranges at the end of this user manual.

HOW SPLIT AIR CONDITIONERS WORK

COOLING MODE

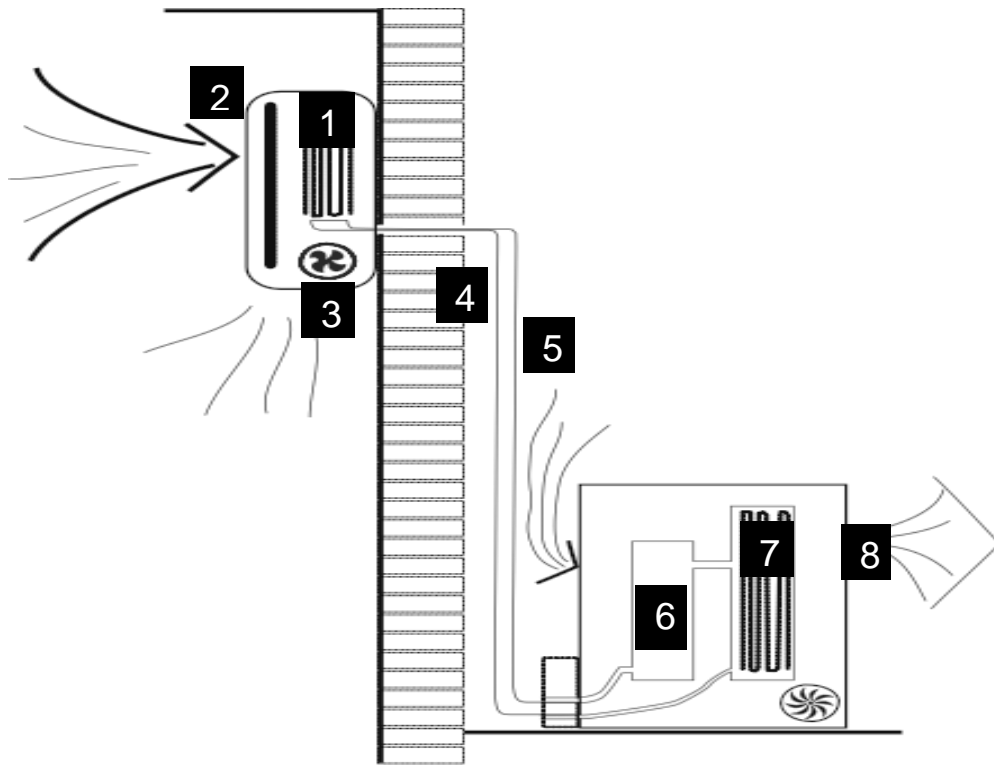

The compressor (6) in the external unit compresses the refrigerant into a high-temperature, high-pressure gas. When this gas flows along the cooling fins of the condenser (7), heat is exuded and the gas condenses into a liquid, which is then led to the evaporator (1) in the indoor unit. The liquid expands into a gas at a low temperature and low pressure. This gas absorbs the warmth of the air in the room, and a fan (3) draws the air through the filter and over the evaporator (1), blowing the cooled air back into the room. The heat is moved to the compressor along with the gas. A fan (8) draws air over the condenser and blows the warm air away.

- | | | |
|---------------|------------------|-------------------|
| 1. Evaporator | 2. Filter | 3. Evaporator Fan |
| 4. Gas Line | 5. Liquid line | 6. Compressor |
| 7. Condenser | 8. Condenser Fan | |

HEAT PUMP MODE

The system operates in reverse: the condenser works as an evaporator, the evaporator as a condenser: warm air is blown into the room. It is ideal as a maintenance heating when outside temperature is not too low and when the indoor temperature is more than 7°C.

DRY MODE

As with cooling, the moisture in the air condenses on the cold evaporator at room temperature acting as a powerful dehumidifier.

SYSTEM DIAGRAM

INDOOR UNIT

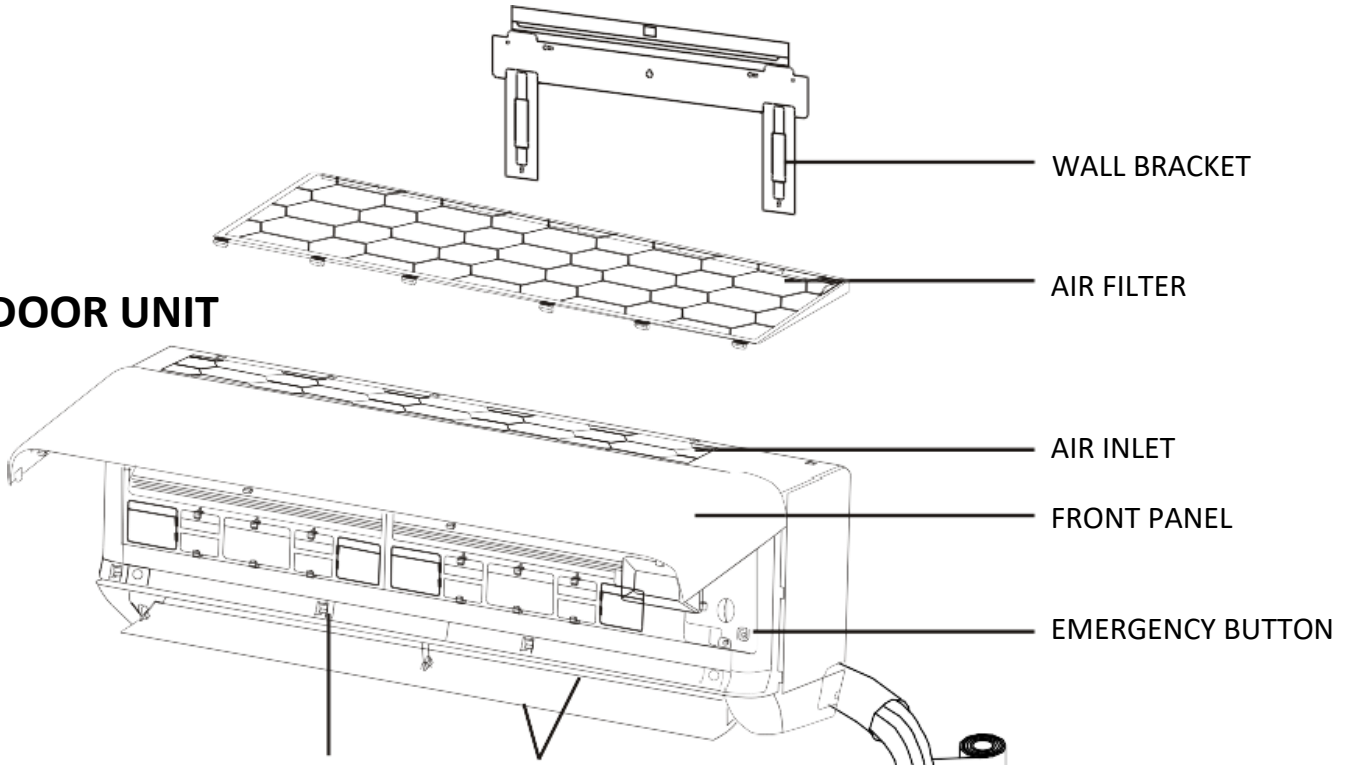

OUTDOOR UNIT

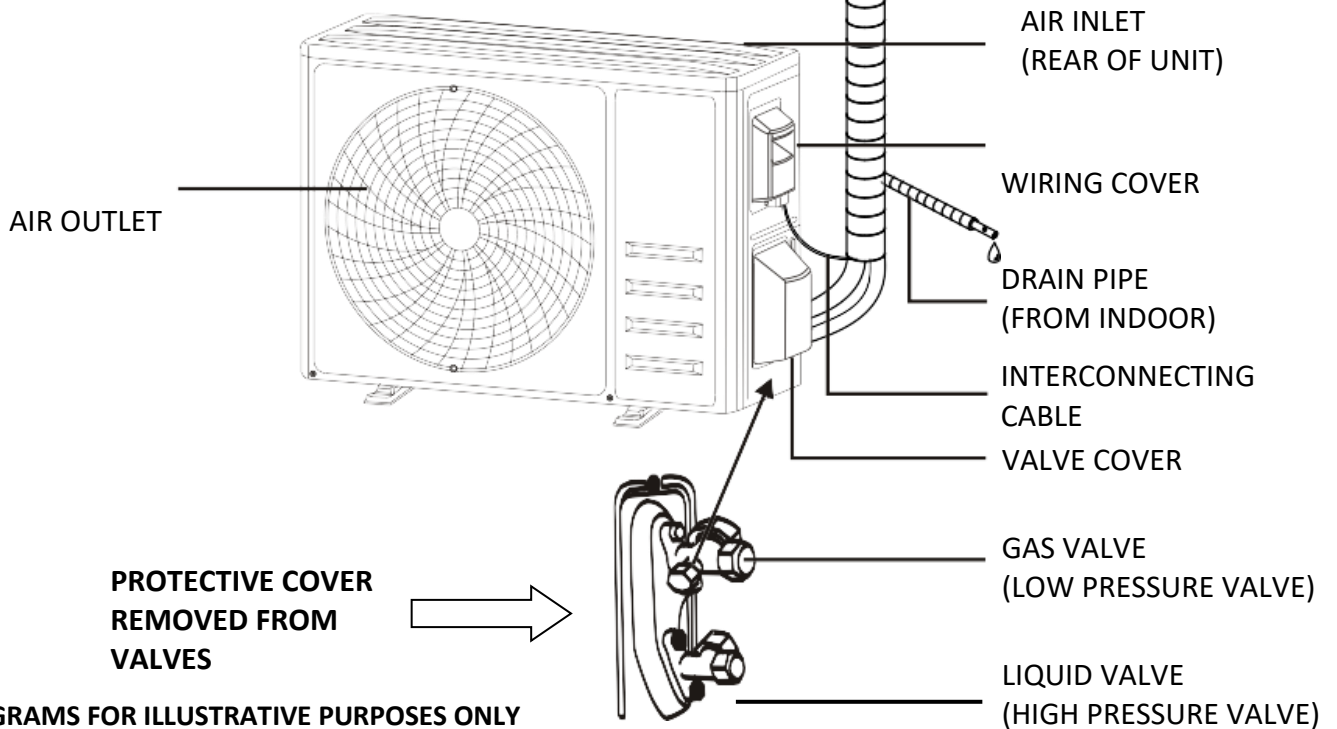

NOTE: DIAGRAMS FOR ILLUSTRATIVE PURPOSES ONLY

PARTS LIST

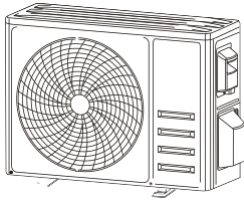

Outdoor Unit x 1



Installation Manual x 1



User Manual x 1



Drain Connector x 1



Rubber Feet Pads x 4



Drainage pipe x 2

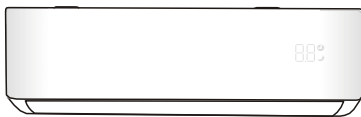

Indoor Unit x 1



Remote Control x 1



5.8m Interconnecting Cable x 1
(Pre-attached)

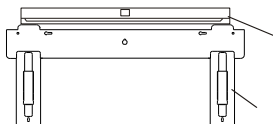

Wall Bracket x 1
(Pre-attached)



5m Pipe kit x 1
(Gas and Liquid pipe)



Power Cable x 1



Screws + Wall Plugs x 6



Putty and PVC Wrap x 1



Wall Sleeve and Cover x 1

**NOTE: DIAGRAMS FOR ILLUSTRATIVE PURPOSES ONLY
THE DESIGN OF THE ACCESSORIES MAY VARY**

INSTALLATION INFORMATION

This air conditioner must be installed by qualified personnel following the requirements of the installation and service manual. Installation and servicing of the appliance must only be conducted by individuals possessing adequate backgrounds and qualifications in electrical, electronic, refrigerant and mechanical fields. Any attempt to install or repair the appliance may result in personal injury and property damage.

- Ensure you pass the service and installation manual onto the qualified engineer you have chosen to install this air conditioner.
- The manufacturer and retailer cannot be responsible for the interpretation of this information, nor can it assume any liability in connection with its use.
- The units are designed for permanent installation.
- The equipment is designed for domestic or office use and we are not making any endorsements for use in industrial or maritime environment.
- Do not place near sources of heat, vapours, industrial machine oil or other flammable gases.
- High-frequency waves generated by radio equipment, welders and medical equipment will interfere with the normal operation of the unit.
- Install this device only when it complies with local/national legislation, ordinances and standards.
- Check the mains voltage and frequency. This unit is only suitable for an earthed electrical supply, connection voltage 220-240 V~ / 50 Hz. The information, specifications and parameter are subject to change due to technical modifications or improvement without any prior notice. The accurate specifications are presented on the nameplate label.
- Please read this installation manual completely before installing the product.
- When the power cord is damaged, replacement work shall be performed by authorised personnel only.
- Installation work must be performed in accordance with all European, national and / or local directives and standards and must be done by authorised personnel only.
- Always make sure to wear the correct personal safety protections such as protective eyewear, gloves, ear protection etc.
- This air conditioner contains a refrigerant and can be classified as pressurised equipment. Therefore always contact an authorised air conditioning engineer for installation and maintenance of the air conditioner.
- The air conditioner must be inspected and serviced on an annual basis by an authorised air conditioning engineer. Annual servicing ensures your appliance continues to run safely and efficiently and helps to prevent costly breakdowns.
- Proof of professional installation and annual servicing by a certified engineer will be required when submitting a warranty claim and failure to provide suitable evidence would invalidate the warranty.

HOW TO OPERATE YOUR AIR CONDITIONER

THE DISPLAY

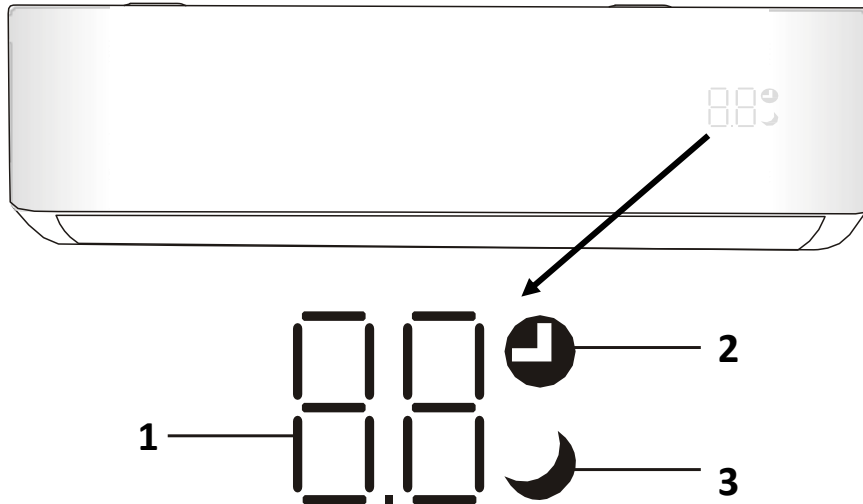

No.	LED	FUNCTION
1		Indicator for Timer, temperature and Error codes.
2		Illuminates when the timer is active.
3		Illuminates when the SLEEP mode is active

EMERGENCY BUTTON

There is an emergency button located under the panel on the front of the indoor unit. This can be used to provide basic control of the unit without the remote control. This is only designed for emergency use and it is advisable to use an insulated material to press the button.

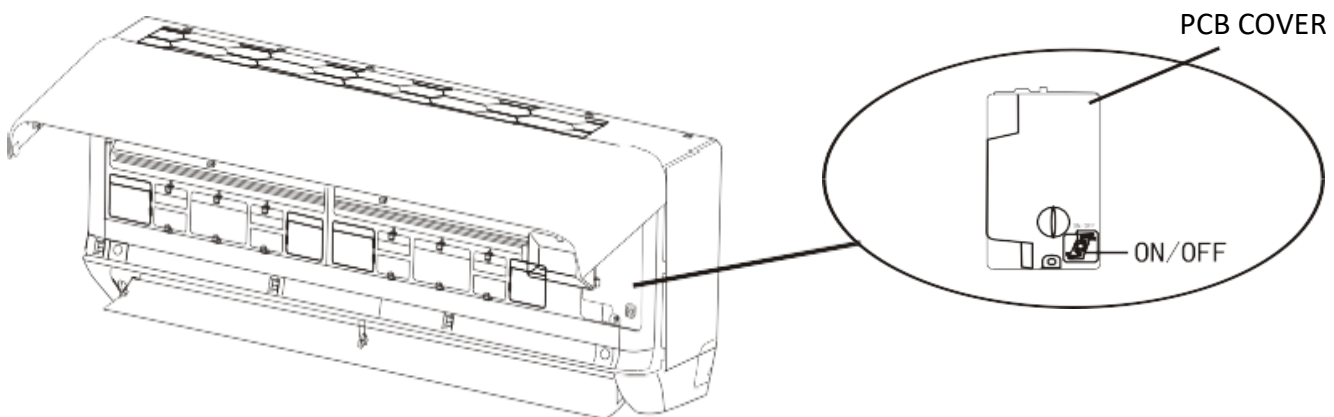

Initial Mode	Operation	Final Mode
Standby	Press the emergency button once	Cooling mode
	Press the emergency button twice within 3 seconds	Heating mode
Running	Press the emergency button once	Off mode

HOW TO OPERATE YOUR AIR CONDITIONER

SETTING UP THE REMOTE

Insert 2 x AAA batteries into the rear of the remote control. When batteries are first inserted or following changing the batteries, the remote must be set up for the type of air conditioner, either COOLING AND HEATING or COOLING ONLY.



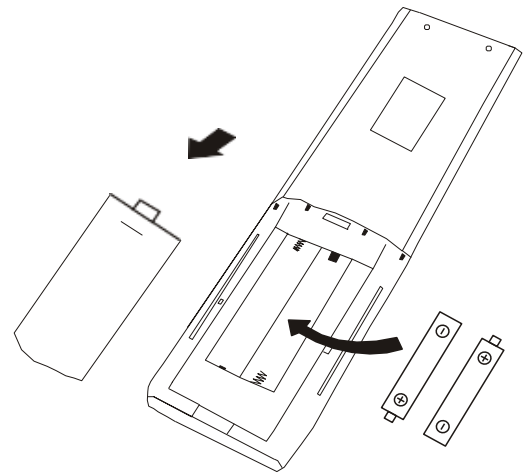

The remote control has a range of up to 8m. Point the remote control at the receiver in the interior unit. A beep confirms that the remote-control signal has been received.



HOW TO OPERATE YOUR AIR CONDITIONER

QUICK START GUIDE

1. With the remote control pointed at the indoor unit, turn the appliance on using the **ON/OFF** button on the remote control.
2. Repeatedly press the **MODE** button to select the desired mode. The display on the remote will show the symbol to indicate the currently selected mode:

	Auto Mode
	Cooling Mode
	Dry Mode
	Fan only Mode
	Heating Mode

3. Use the **FAN** button to select the fan speed. The fan speed indicator on the remote will show the currently selected fan speed (7 speeds + Auto):



4. Use the \wedge and \vee buttons to select the desired room temperature. The temperature selected will be displayed both on the remote and the front panel of the indoor unit.

HOW TO OPERATE YOUR AIR CONDITIONER

THE REMOTE CONTROL DISPLAY





SYMBOL	MEANING
	Battery indicator
	Auto Mode
	Cooling Mode
	Dry Mode
	Fan only Mode
	Heating Mode
	ECO Mode
	Timer
	Temperature indicator
	Fan speed: Auto/low/low-mid/mid/mid-high/high
	Mute function
	TURBO function
	Vertical auto swing
	Horizontal auto swing
	SLEEP function
	Health function (Not applicable)
	I FEEL function
	8°C heating function
	Signal indicator
	Gentle breeze
	Child-Lock
	Display ON/OFF
	Self-Clean function
	Anti-Mildew



*The functions available on the remote varies depending on the specification and features of the model of air conditioner purchased.

HOW TO OPERATE YOUR AIR CONDITIONER

BUTTONS



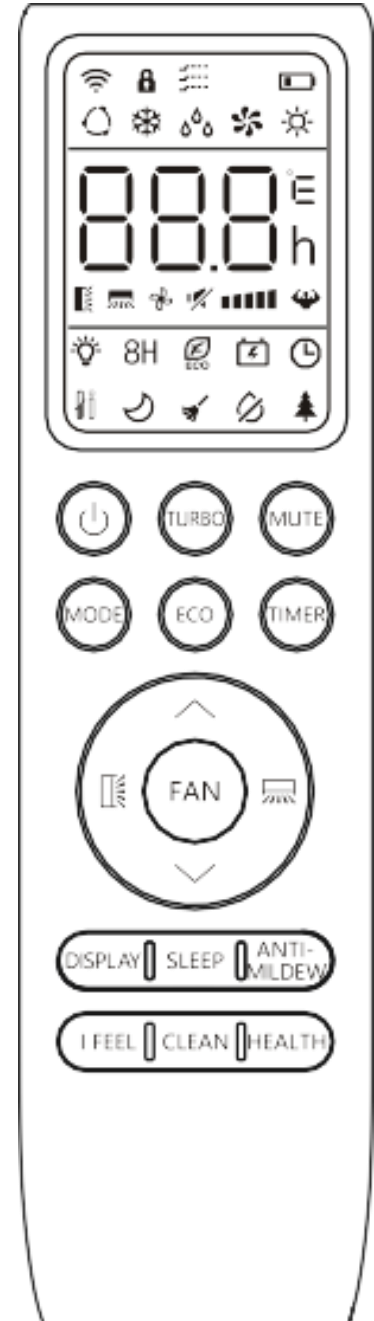



SYMBOL	FUNCTION
	Press to turn the air conditioner on and off
	Press to increase the desired temperature, or set the Timer.
	Press to decrease the desired temperature, or set the Timer.
	Press to stop or start vertical swing. Used to set the vertical airflow direction.
	Press to stop or start horizontal swing. Used to set the horizontal airflow direction.
FAN	Press to select the fan speed between: auto/mute/low/low-mid/mid/mid-high/high/turbo.
TURBO	Press to activate/deactivate the TURBO function.
	Press and hold to change between displaying temperatures in Celsius and Fahrenheit.
MUTE	Press to activate/deactivate the MUTE function.
MODE	Press to select the mode between: AUTO, COOL, DRY, FAN and HEAT.
ECO	Press to activate/deactivate the ECO function.
	Press and hold to activate/deactivate the 8°C heating function.
TIMER	Press to set an On/Off timer.
DISPLAY	Press to turn the display on and off.
SLEEP	To switch-on/off the function SLEEP.
ANTI-MILDEW	To activate/deactivate the ANTI-MILDEW function.
I FEEL	To switch-on/off the I FEEL function.
CLEAN	Not available on this unit
HEALTH	Not available on this unit
BUTTON COMBINATIONS	
MODE + TIMER	Press together to activate/deactivate the CHILD-LOCK function.
FAN + MUTE	To activate/deactivate the GENTLE BREEZE function.

















*The functions available on the remote varies depending on the specification and features of the model of air conditioner purchased.

See the following pages for more detailed information on the functions





SETTING UP THE WiFi APP

MODES		COOLING	Cools the room when the room temperature is above the desired temperature set. It will also help reduce humidity at the same time.							
		<ol style="list-style-type: none"> 1. Press the MODE button until the COOL indicator appears. 2. Set the desired room temperature using the ^ and v buttons (16 - 31°C) 3. Use the FAN button to set the fan speed. 								
		HEATING	Heats the room when the room temperature is below the desired temperature set.							
		<ol style="list-style-type: none"> 1. Press the MODE button until the HEAT indicator appears. 2. Set the desired room temperature using the ^ and v buttons (16 - 31°C) 3. Use the FAN button to set the fan speed. 								
		DRY	Removes moisture from the air, by creating a cold surface within the indoor unit for moisture to condensate on.							
		<ol style="list-style-type: none"> 1. Press the MODE button until the DRY indicator appears. <p>The fan speed will always be low in this mode and the fan speed and temperature cannot be adjusted in dry mode</p>								
	FAN	Helps air circulation within the room while acting as a fan, with no heating or cooling function.								
	<ol style="list-style-type: none"> 1. Press MODE button until the FAN indicator appears. 2. Use the FAN button to set the fan speed, cycling through AUTO, MUTE, LOW, LOW-MID, MID, MID-HIGH, HIGH and TURBO 									
	AUTO	The operating mode will automatically be selected depending on the room temperature, and aims for a room temperature of 23°C.								
	<ol style="list-style-type: none"> 1. Press the MODE button until the AUTO indicator appears. 2. The room temperature determines how the air conditioner operates. It is not possible to change the temperature in this mode the unit will operate to achieve best performance. The operation logic is as below: <table border="1" data-bbox="606 1209 1236 1355"> <thead> <tr> <th>Ambient Temperature</th> <th>Operation Mode</th> </tr> </thead> <tbody> <tr> <td><20°C</td> <td>Heating</td> </tr> <tr> <td>20°C - 26°C</td> <td>Dry</td> </tr> <tr> <td>>26°C</td> <td>Cool</td> </tr> </tbody> </table> 3. Set the desired room temperature using the ^ and v buttons (16 - 31°C) 4. Use the FAN button to set the fan speed. 		Ambient Temperature	Operation Mode	<20°C	Heating	20°C - 26°C	Dry	>26°C	Cool
	Ambient Temperature	Operation Mode								
<20°C	Heating									
20°C - 26°C	Dry									
>26°C	Cool									
TIMER		OFF TIMER	Set while the air conditioner is running, so it turns off after the period of operation set.							
		<ol style="list-style-type: none"> 1. With the air conditioner running, press the TIMER button. 2. Use the ^ and v buttons to set the duration (max 24 hours). 3. Press the TIMER button to confirm. <p>Once the running time has elapsed, the appliance will switch itself off. To cancel the timer function before the set time has elapsed, press the TIMER button again.</p>								
TIMER		ON TIMER	Set while the air conditioner is in standby, so it turns on after the period set and operates with the previous settings.							
		<ol style="list-style-type: none"> 1. With the air conditioner in standby, press the TIMER button. 2. Use the ^ and v buttons to set the duration (max 24 hours). 3. Press the TIMER button to confirm. 4. The operating parameters can then be adjusted using the ^ and v, MODE and FAN buttons. <p>Once the running time has elapsed, the appliance will start operating.</p>								

SETTING UP THE WiFi APP

		To cancel the timer function before the set time has elapsed, press the TIMER button again.	
SWING		VERTICAL	The outer flap on the unit will slowly move up and down to alter the vertical direction of the airflow.
		<ol style="list-style-type: none"> 1. Press the  button to start the vertical swing. 2. Press the  button again to stop the flap in its current position. 	
		HORIZONTAL	The inner louvres on the unit will slowly twist left and right to alter the horizontal direction of the airflow.
		<ol style="list-style-type: none"> 1. Press the  button to start the horizontal swing. 2. Press the  button again to stop the internal louvres in their current position. 	
ADDITIONAL FUNCTIONS		TURBO	Operates at highest fan speed for 15 minutes to maximise performance, when heating or cooling a room.
		<ol style="list-style-type: none"> 1. Press the TURBO button to activate turbo mode 2. The fan and compressor will run at maximum speed for 15 minutes, before returning to their previously set levels. <p>To cancel turbo mode, press the TURBO button again.</p>	
		MUTE	Operates at lowest fan speed to minimise the operating noise of the indoor unit.
		<ol style="list-style-type: none"> 1. Press the MUTE button to activate the function. 2. Press the MUTE button again to deactivate the function 	
		ECO	Automatically adjusts the settings to reduce energy usage.
		<ol style="list-style-type: none"> 1. Press the ECO button to activate the function. 2. Press the ECO button again to deactivate the function 	
		SLEEP	Operates at lowest fan speed to minimise the operating noise of the indoor unit for 10 hours, before returning to normal operation.
		<ol style="list-style-type: none"> 1. Press the SLEEP button to activate the function. <p>The function will automatically stop after 10 hours, but can be cancelled earlier by pressing the SLEEP button.</p>	
		ANTI-MILDEW	The indoor unit will operate in fan mode for 15 minutes to remove any moisture, before turning off.
		<ol style="list-style-type: none"> 1. Press the ANTI-MILDEW button to activate the function. <p>The function will automatically stop after 15 minutes.</p>	
	I FEEL	The room temperature is measured by the remote control instead of the indoor unit, allowing you to optimise the temperature to ensure comfort.	
	<ol style="list-style-type: none"> 1. Press the I FEEL button to activate the function. 2. Press the I FEEL button again to deactivate the function 		
	SELF-CLEAN	A 30 minute program designed to remove dirt and bacteria from within the indoor unit.	
	<ol style="list-style-type: none"> 1. Press the POWER button to turn off the air conditioner if it is running. 2. Press the CLEAN button to activate the function. <p>The function will run for 30 minutes before returning back to the original operation. To cancel the function once started, press the POWER button.</p> <p>For optimal performance, this function should be run when the outside temperature is above 5°C, and it is advisable for it to be run every 3 months.</p>		
	8°C HEATING		
	<ol style="list-style-type: none"> 1. Press and hold the ECO button for 3 seconds to enter the mode. 		
	<ol style="list-style-type: none"> 1. Press and hold the ECO button for 3 seconds to exit the mode. 		

SETTING UP THE WiFi APP

ADDITIONAL SETTINGS / FEATURES		CHILD LOCK	Locks the buttons on the remote to prevent the accidental alteration of settings.
		<ol style="list-style-type: none"> 1. Press the MODE and TIMER buttons together to activate the function 2. Press them again to cancel the function. 	
		GENTLE BREEZE	Operates with the flap on the indoor unit closed, to provide a gentle breeze into the room.
		<ol style="list-style-type: none"> 1. Press the FAN and MUTE buttons together to activate the function 2. Press them again to cancel the function. 	
	°C/°F	TEMP UNIT	Change the temperature that displays on the remote and unit between Celsius and Fahrenheit.
		<ol style="list-style-type: none"> 1. Hold the TURBO button for 5 seconds to change the temperature display 2. Repeat to change back. 	
		WiFi SETUP	Used to connect the indoor unit to your SMART app. Each indoor should be set up separately
		There are 3 options for activating the WiFi setup, as shown below. For more detail see the WiFi connection section of this manual.	
		Method 1	<ol style="list-style-type: none"> 1. Press the DISPLAY button 6 times within 8 seconds. The unit will then bleep 3 times and CF or AP will be shown on the indoor display.
		Method 2	<ol style="list-style-type: none"> 1. Press the ECO button 6 times within 8 seconds. The unit will then bleep 3 times and CF or AP will be shown on the indoor display.
Method 3		<ol style="list-style-type: none"> 1. Press and hold the MODE and ^ buttons for 3 seconds. The unit will then bleep 3 times and CF or AP will be shown on the indoor display.	
	FAN SPEED	In most modes the fan speed can be adjusted.	
	<ol style="list-style-type: none"> 1. Press the FAN button to change between the fan speeds, the available options are: auto, mute, low, low-mid, mid, mid-high, high, turbo 		
	BATTERY LEVEL	The remote will show you the current battery level	
	When the battery level is showing as low, the batteries in the remote control should be changed, to ensure you can continue to operate the air conditioner.		

SETTING UP THE WiFi APP

IMPORTANT INFORMATION

HEATING MODE

When the air conditioner is placed in heating mode, the indoor unit will appear to be inactive while it follows its pre-heat procedure to heat the evaporator coils. Once the coils have heated, the indoor fan will start to run. This process usually takes 1 – 3 minutes, and is designed to ensure that cold air is not circulated.

During heating mode, the appliance can automatically activate a defrost cycle, which is essential to clean the frost on the condenser so as to recover its heat exchange function. This procedure usually lasts for 2-10 minutes. During defrosting, the fan in the indoor unit will stop operation. After defrosting, it will return to HEATING mode automatically.

AUTO RESTART

The air conditioner will automatically restart when electricity is restored after a power cut. If in doubt, check the settings.

RANGE OF INTERNAL THERMOSTAT

The internal thermostat can be set at a desired temperature between 16 and 31°C. Note that whether the desired value is achieved depends on the room size, temperature and insulation of the room.

RANGE OF HEAT PUMP FUNCTION

The heat function can be used when the external ambient temperature is above -20°C. The performance of the heat pump will degrade with lowering external temperatures. Please note the performance will reduce when the outdoor temperature drops below 5°C.

CAPACITY

The required cooling or heating capacity depends greatly on the location and/or use of the room where the air conditioner is installed. Strong sunlight and the presence of people, lights or equipment creates an additional heat load. Normal living spaces require about 350 Btu per square meters of floor surface. In strong sunlight or if other sources of heat are present, this may be as much as 1200 Btu per sqm.

Tip: On warm days, let the air conditioner cool the room as much as possible during the night and keep the temperature constant from night to daytime.

SETTING UP THE WiFi APP

BEFORE YOU START

- Ensure your router provides a standard 2.4ghz connection.
- If your router is dual band ensure that both networks have different network names (SSID). The provider of your router / Internet service provider will be able to provide advice specific to your router.
- Ensure the router is as close as possible to the indoor unit during setup.
- Once the app has been installed on your phone, turn off the data connection, and ensure your phone is connected to your router via WIFI.

DOWNLOAD THE APP TO YOUR PHONE

Download the "SmartLife" app, from your chosen app store, using the QR codes below, or by searching for the app in your chosen store.



Android



IOS

The unit can also be controlled using the "Tuya Smart" app which is also available in the app stores. We would advise on using the version above which is optimised for use with your air conditioner as we cannot guarantee the correct functionality of all features when other versions are used.



Android



IOS

SETTING UP THE WiFi APP

CONNECTION METHODS AVAILABLE FOR SETUP

The air conditioner has two different setup modes, Quick Connection and AP (Access Point). The quick connection is a quick and simple way to set the unit up. The AP connection uses a direct local WiFi connection between your phone and the air conditioner to upload the network details.

Please ensure your device is in the correct WiFi connection mode for the connection type you are attempting, the flashing of the WiFi light on your air conditioner will indicate this.

CONNECTION TYPE	DISPLAY OF INDOOR UNIT SHOWS
Quick Connection	CF
AP (Access Point)	AP

RESETTING THE WiFi CONNECTION ON THE INDOOR UNIT

There are 3 different methods for resetting the WiFi module on the indoor unit, which can be done using your mobile phone:

Method 1	Press the DISPLAY button 6 times within 8 seconds.
Method 2	Press the ECO button 6 times within 8 seconds.
Method 3	Press and hold the MODE and \wedge buttons for 3 seconds.

Once the above has been followed, it will bleep 3 times, you should allow upto 10 seconds for the connection mode to be displayed on the indoor unit before continuing connection.

If no connection is made within 2 hours, the WiFi will automatically turn off, and the connection should be reset following the steps above to reactivate the function.

.

CHANGING BETWEEN CONNECTION TYPES

Changing the air conditioner between the two WiFi connection modes is exactly the same process as resetting the connection:

Method 1	Press the DISPLAY button 6 times within 8 seconds.
Method 2	Press the ECO button 6 times within 8 seconds.
Method 3	Press and hold the MODE and \wedge buttons for 3 seconds.

SETTING UP THE WiFi APP

REGISTER THE APP

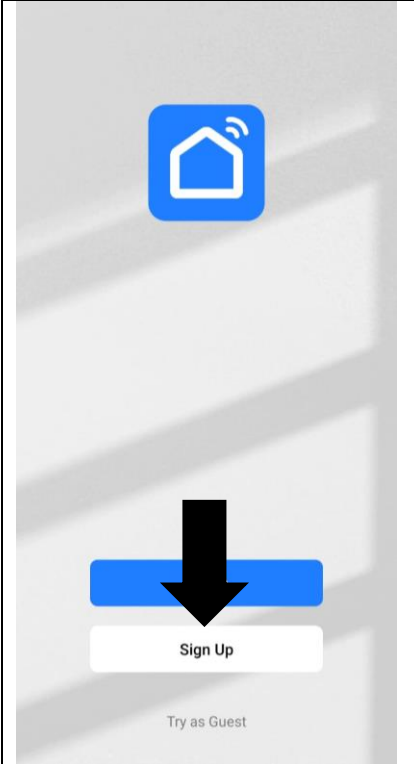
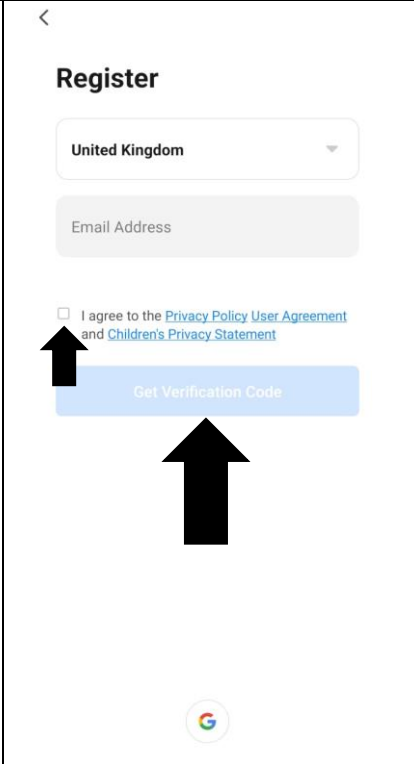
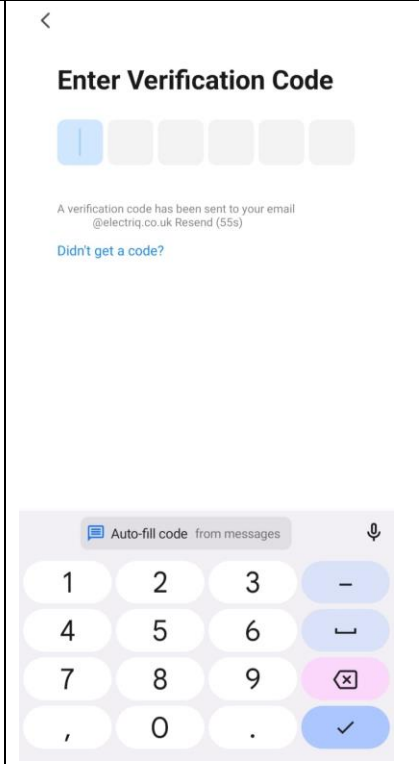
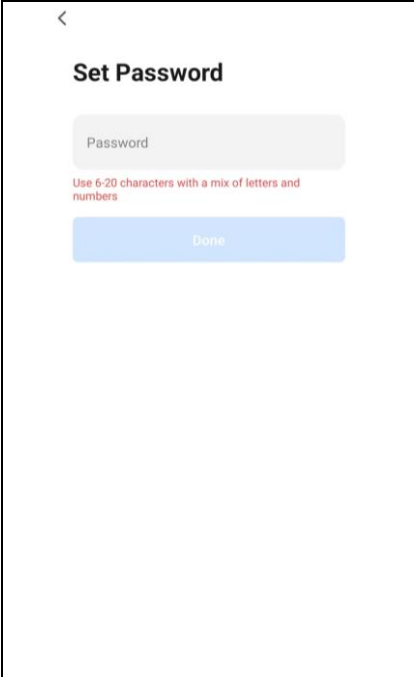
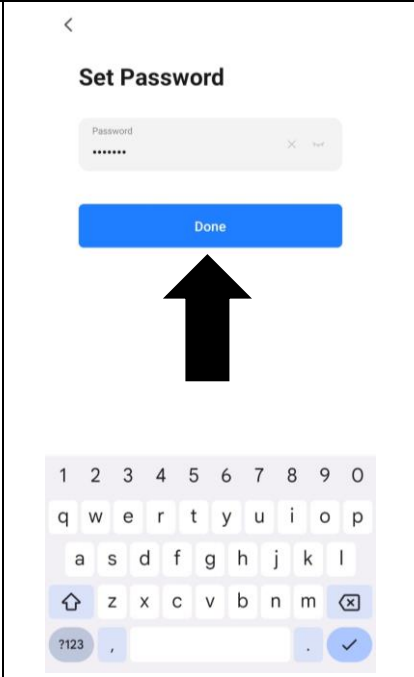
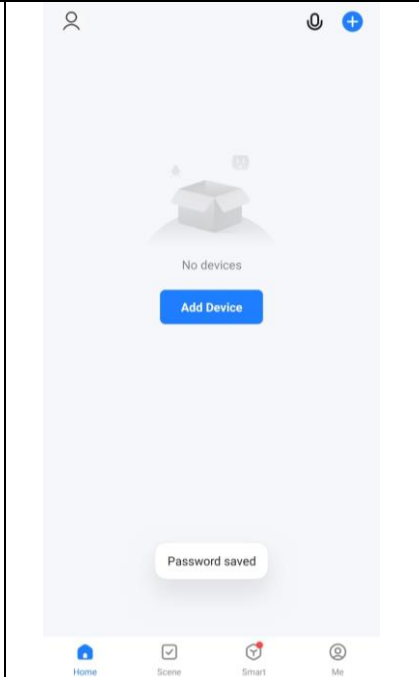

Upon the first use, an account will need to be registered which can be done as below:

<p>1 Press the Sign Up button at the bottom of the screen.</p>	<p>2 Change the country (if required) before entering your email address, ticking the checkbox, and pressing the Get Verification Code button.</p>	<p>3 A verification code will be sent to your email address. Type it into the boxes.</p>
		
<p>4 Create a password following the requirements.</p>	<p>5 Once it has been entered, press Done.</p>	<p>6 The app will then load to the main device screen.</p>
		

SETTING UP THE WiFi APP

CONNECTING USING QUICK CONNECTION MODE

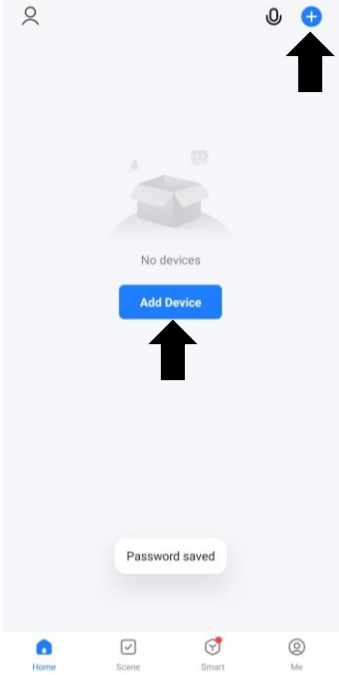
Before initiating the connection, make sure the unit is in standby mode, with the display on the indoor unit showing CF. If not follow the instructions for changing the connection mode. You should also ensure your phone is connected to the WiFi network. (We advise turning mobile data off during setup)

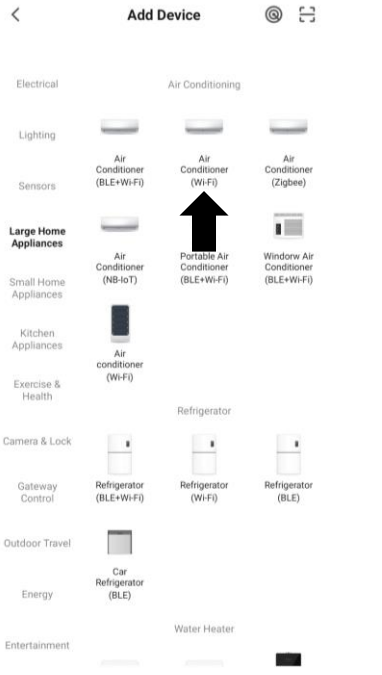
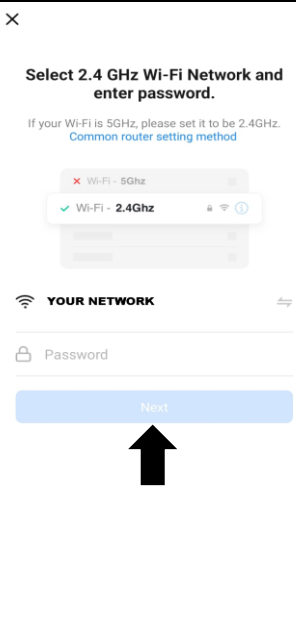
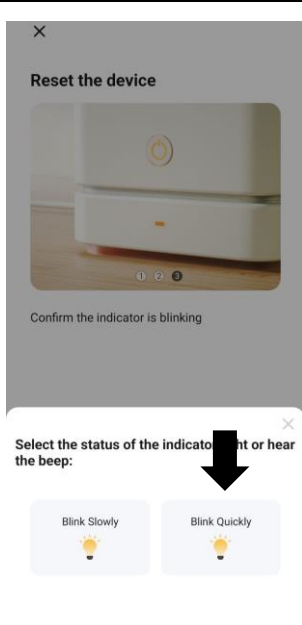
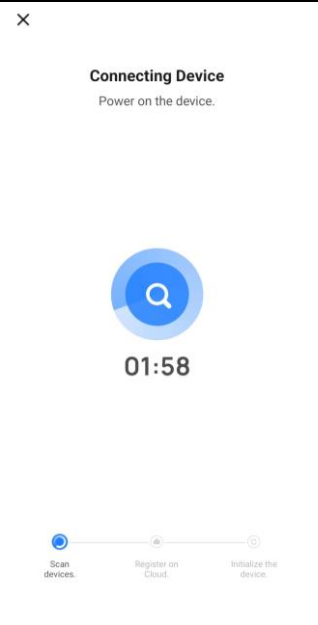
<p>1 Press on Add Device, or the + in the top right corner.</p>	<p>2 Press the Large Home Appliances tab on the left</p>	<p>3 Press on Air Conditioner (WiFi)</p>
		
<p>4 Ensure your WiFi network is shown before entering your password*, and pressing Next.</p>	<p>5 As you have already prepared your air conditioner, Press Next On the screens asking to Reset the device. Then select Blink Quickly.</p>	<p>6 The app will now attempt to connect your air conditioner to the internet.</p>
		
<p>7 Once successfully added the app will take you to the device screen. If connection fails, retry connection using the quick connection (CF) mode, or alternatively follow the Access Point (AP) mode connection method.</p>		

* Passwords are case sensitive, and often on a label attached to your router.

Instructions are for guidance only, due to continual development of the app, the process may differ from the above.

SETTING UP THE WiFi APP

CONNECTING USING ACCESS POINT (AP) MODE

Before initiating the connection, make sure the unit is in standby mode, with the display on the indoor unit showing AP. If not follow the instructions for changing the connection mode. You should also ensure your phone is connected to the WiFi network. (We advise turning mobile data off during setup)

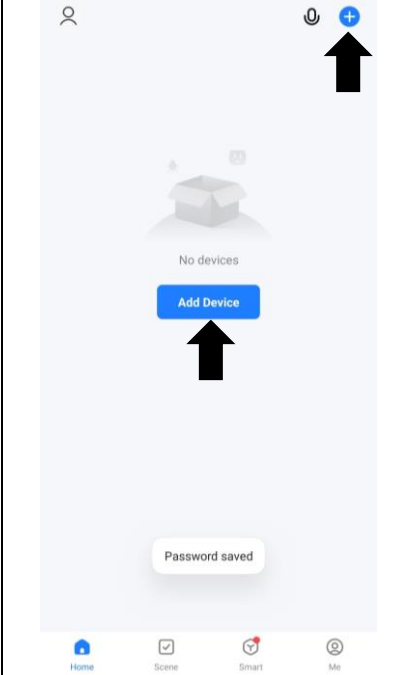
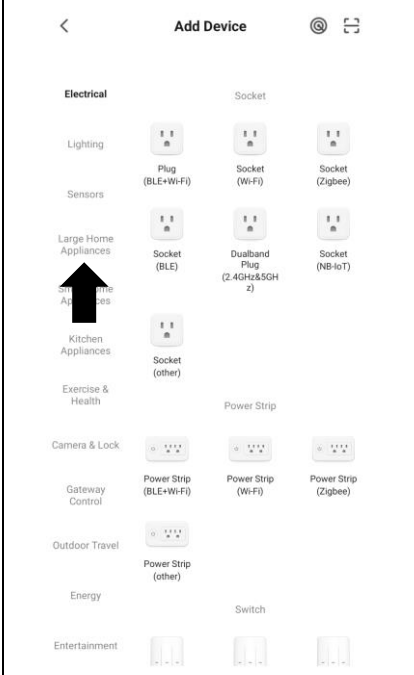
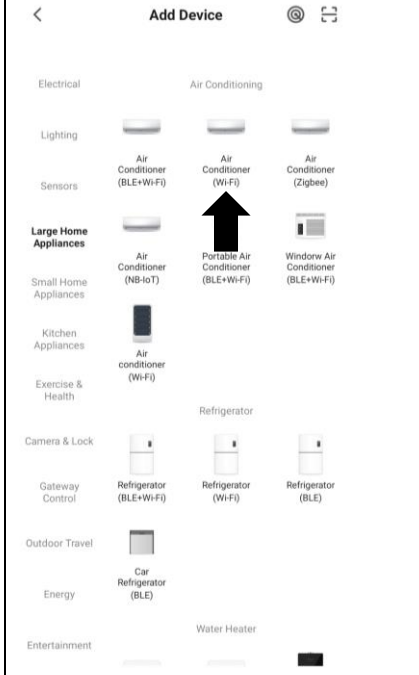
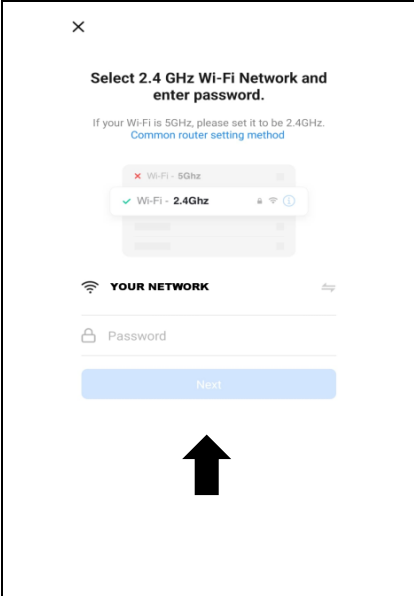
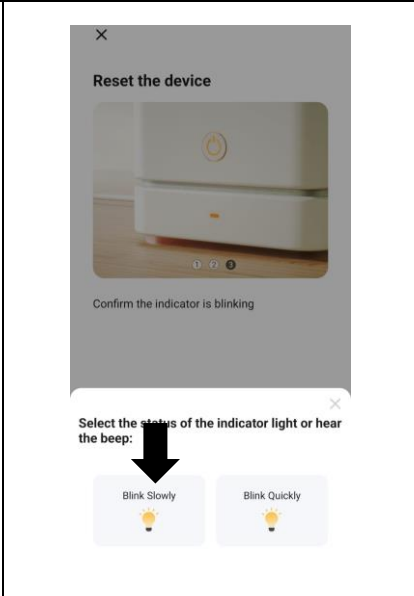
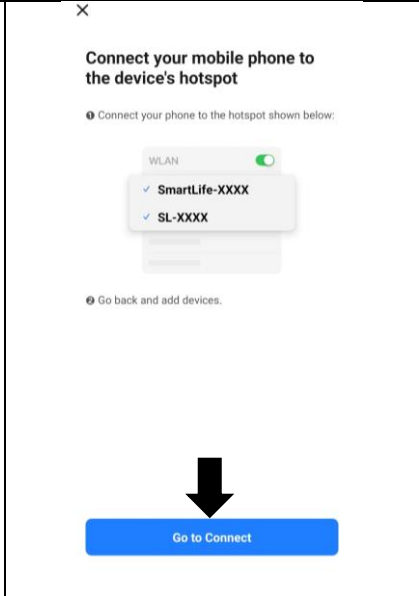
<p>1 Press on Add Device, or the + in the top right corner.</p>	<p>2 Press the Large Home Appliances tab on the left</p>	<p>3 Press on Air Conditioner (WiFi)</p>
		
<p>4 Ensure your WiFi network is shown before entering your password*, and pressing Next.</p>	<p>5 As you have already prepared your air conditioner, Press Next on the screens asking to reset the device. Then select Blink Quickly.</p>	<p>6 Use the Go to connect button to leave the app, and connect your phone to the WiFi hotspot created by the air</p>
		
<p>6 Return to the app and it will attempt to connect your air conditioner to the internet.</p>		
<p>7 Once successfully added the app will take you to the device screen.</p>	<p>If connection fails, retry connection using the Access Point (AP) mode, or alternatively follow the Quick Connection (CF) mode connection method.</p>	

* Passwords are case sensitive, and often on a label attached to your router.

Instructions are for guidance only, due to continual development of the app, the process may differ from the above.

USING THE WiFi APP

THE HOME SCREEN

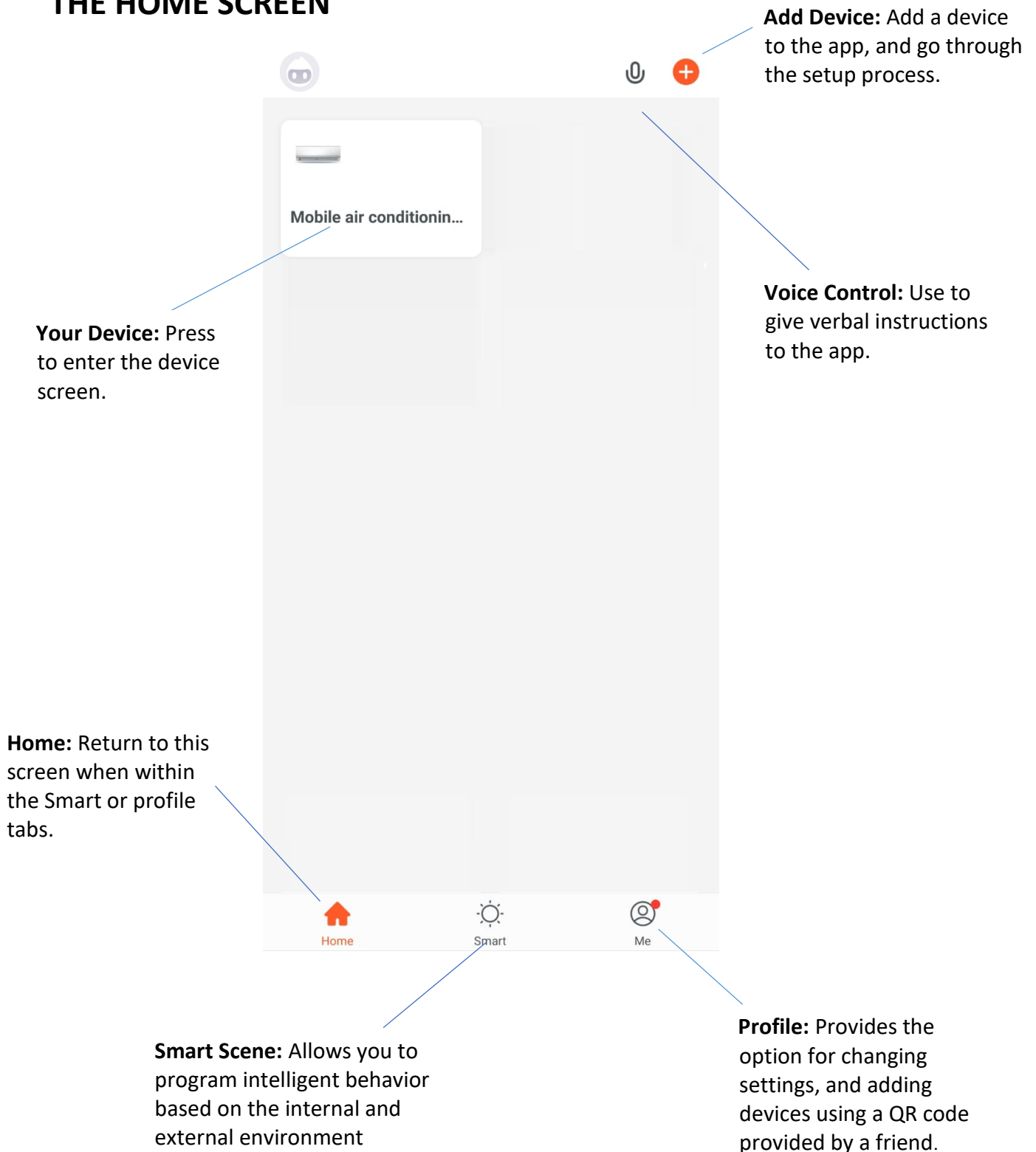

Each device has its own entry on the home screen to allow the user to either quickly turn the unit on or off, or to enter the device screen to make other changes.

USING THE WiFi APP

THE DEVICE SCREEN

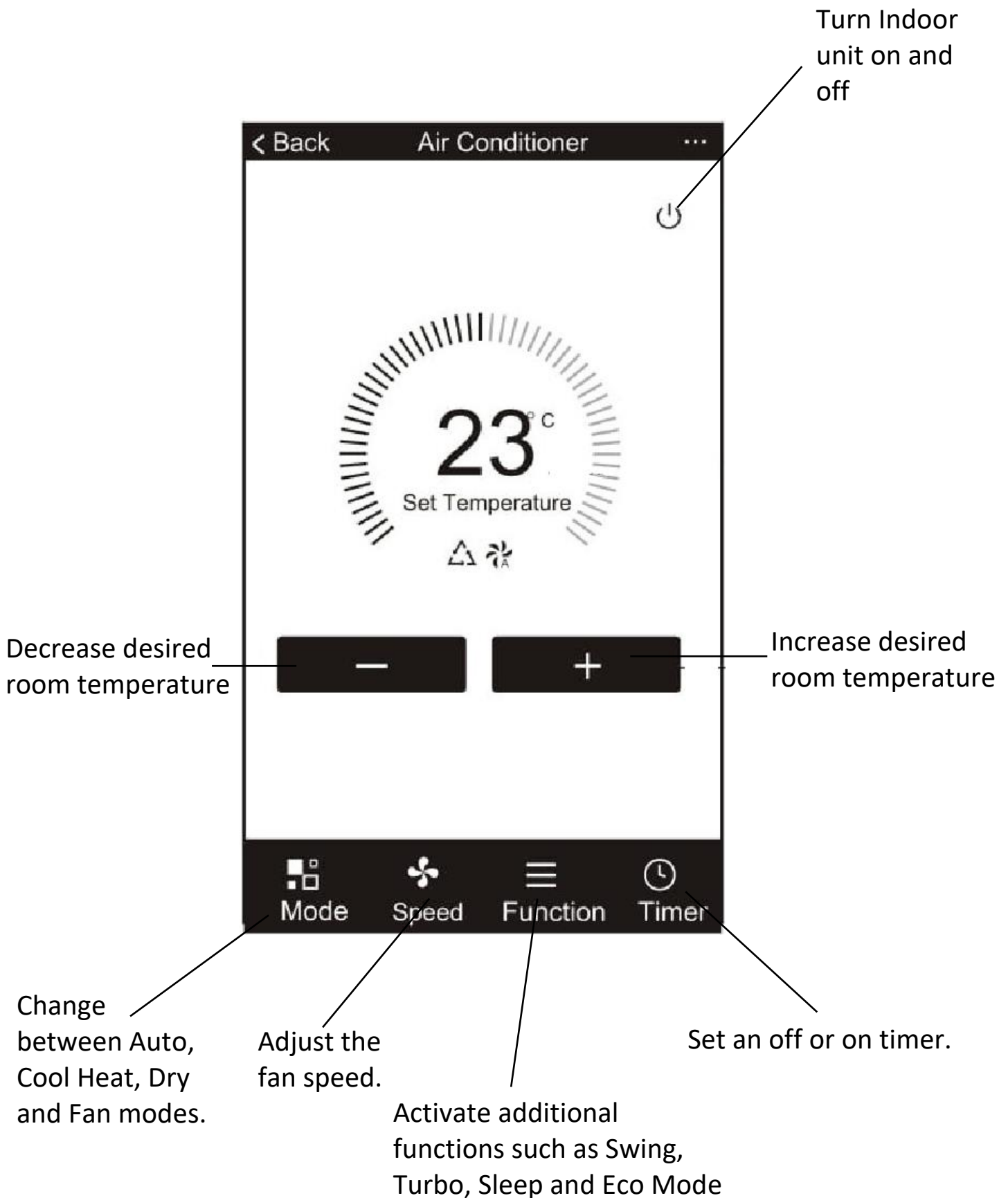

USING THE WiFi APP

SMART SCENES

Smart Scenes is a powerful tool providing the option to customise the operation of the air conditioner based both on conditions within the room and outside influences. This gives the user the option of specifying much more intelligent actions. These are split into two categories Scene and Automation.

SCENE

Scene allows for a one touch button to be added to the Home screen. The button can be used to change a number of settings in one go, and can change all the settings within the unit. A number of scenes can easily be setup, allowing the user to easily change between a number of preset configurations.

Below is an example of how to set up a scene:

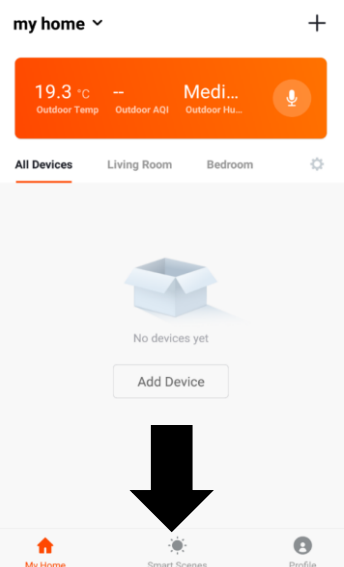
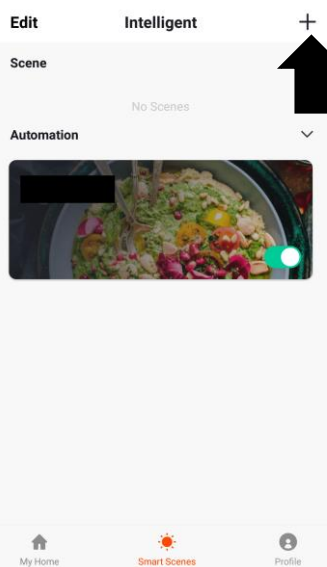
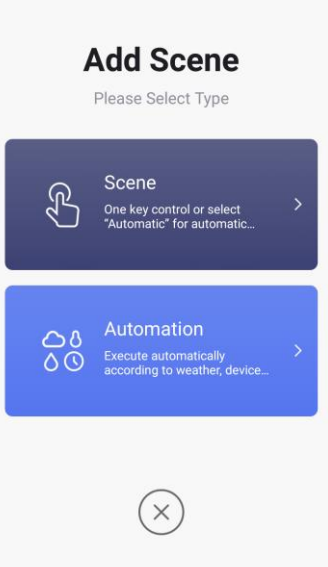
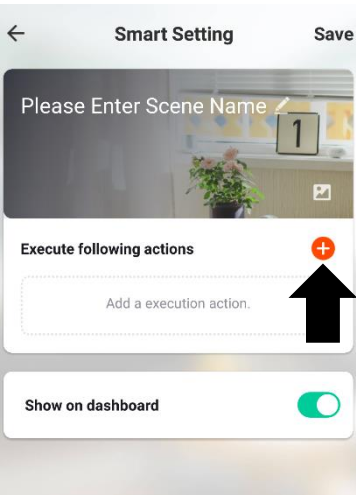
1	Press the Smart Scene tab at the bottom of the Home screen	2	Press the + in the top right corner to add a smart scene.	3	Press Scene to create a new Scene
					
4	<p>Press the Pen next to Please Enter Scene Name to input the name for your Scene.</p> <p>Show on Dashboard: Leave this on if you require the scene to be displayed as a button on the Home Screen.</p> <p>Press the Red Plus to add the action required. Then select the air conditioner from the list of devices.</p>			5	<p>Choose the function, set the value for the function, and then press the back button in the top right corner, to return to the previous screen.</p>
6		<p>Once all the functions required have been added, press the Save button in the top right corner to finalise and save your new Scene</p>			

USING THE WiFi APP

AUTOMATION

Automation allows an automatic action to be set up for the device. This can be triggered by the Time, indoor temperature, humidity of the room, weather conditions, and a range of other influences.

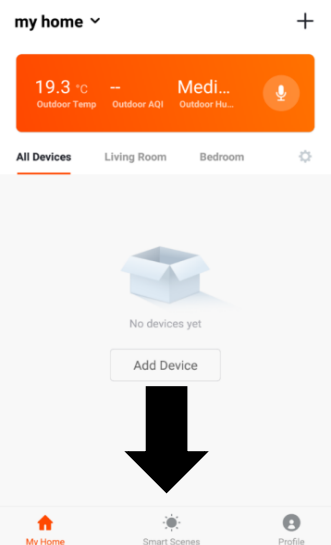
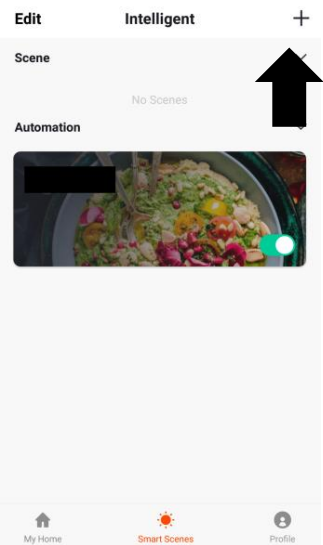
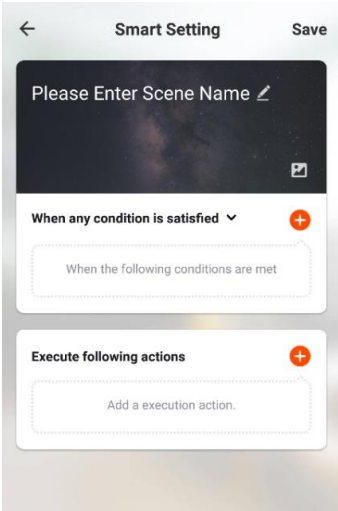
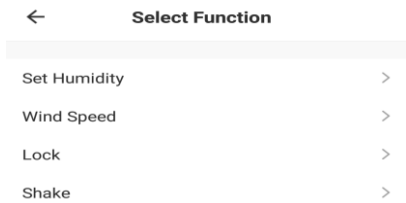
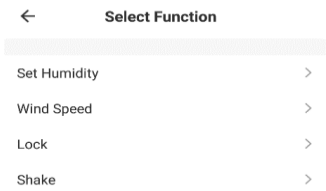
1	Press the Smart Scene tab at the bottom of the Home screen	2	Press Automation to create a new Automation scene
			
<p>Setup is very similar to the scene setup on the previous page, and includes an extra section for specifying a trigger for the scene to start.</p> <p>Press the Pen next to Please Enter Scene Name to input the name for your Scene</p> <p>Press the Red + next to When any condition is satisfied to add the trigger</p> <p>Press the Red + next to Execute following actions to add the action required. Then select the air conditioner from the list of devices.</p>		<p>5</p> 	<p>Select the condition when the automation should start. A number of triggers can be combined.</p> 
6	Chose the function, set the value for the function, and then press the back button in the top right corner, to return to the previous screen.	<p>7</p> 	<p>Once all the functions required have been added, press the Save button in the top right corner to finalise and save your new scene.</p> <p>The automation is now set up, it can be turned on and off using the toggle on the image shown on step 2.</p>

USING THE WiFi APP

PROFILE TAB

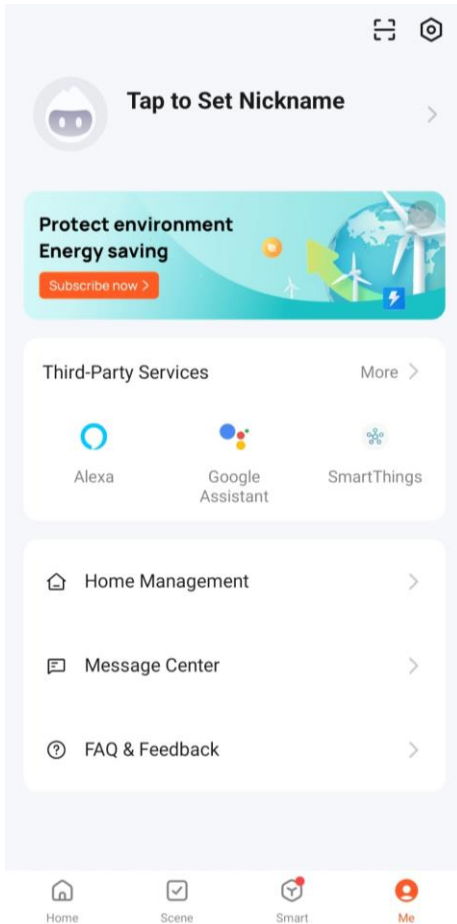

The profile tab gives you the option to edit both your detail, and use the added features of the unit, such as setting up room management, where appliances can be grouped by rooms.

This will also show you the third party support offered on the app, for linking the product up with Google Home and Amazon Alexa.

DEVICE SETTINGS

When in the device screen further settings for the device can be accessed, by pressing on the three dots in the top right hand corner.

CHANGING THE NAME OF YOUR DEVICE

The top option within this allows you to change the name of the device to something relevant to the use of the product, such as “Living Room Air Conditioner”. Within the menu, you also have the option of setting up a pattern lock or change your password.

SHARE DEVICE

This allows you to share access to the controls of your air conditioner with friends and family.

THIRD PARTY CONTROL

This will take you through step by step how to connect the device to your Amazon Alexa or Google Home device.

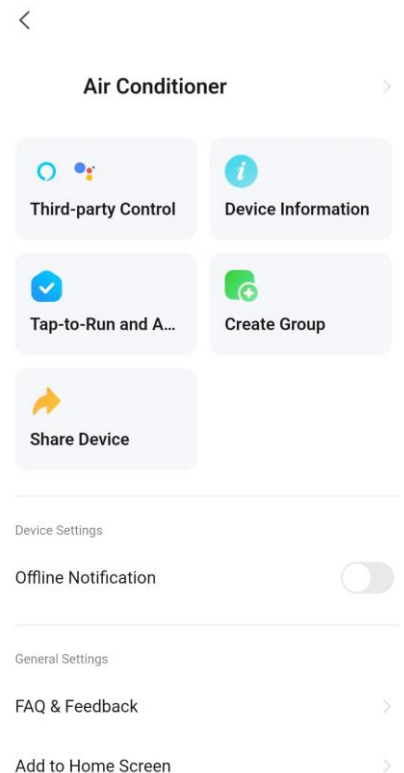

CLEANING AND MAINTENANCE

- Before cleaning, you must turn off the air conditioner and disconnect the power supply for at least 5 minutes.
- Under no circumstances should the air conditioner be flushed with water.
- Volatile liquid (e.g. thinner or gasoline) will damage the air conditioner, so only use soft dry cloth or wet cloth dipped with neutral detergent to clean the air conditioner.
- Clean the filter screen regularly to avoid it clogging with dust, which will affect the airflow to the unit. When the operating environment is dusty, the cleaning frequency should be increased appropriately.
- After removing the filter screen, do not touch the fins of the indoor unit, as these can be sharp.

CLEANING THE UNIT

It is advisable to clean the air conditioner regularly to maintain its appearance and performance.

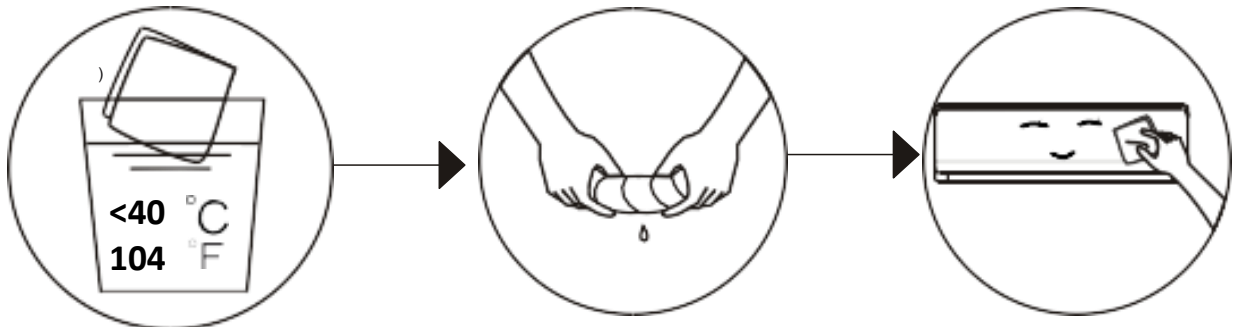

- Wipe with a warm damp cloth (ensuring it has been wringed out)
- Gently wipe the surfaces of the air conditioner.

REMOVAL OF THE AIR FILTER

- Grasp the raised handle on the filter, and then pull the filter out from the top of the unit by twisting it, so that the upper edge of the filter is separated from the unit. The filter can be removed by lifting the filter upwards.
- When installing the filter, first insert the lower end of the filter screen into the corresponding position of the unit, and then squeeze the upper end of the filter into the corresponding buckling position of the unit body.

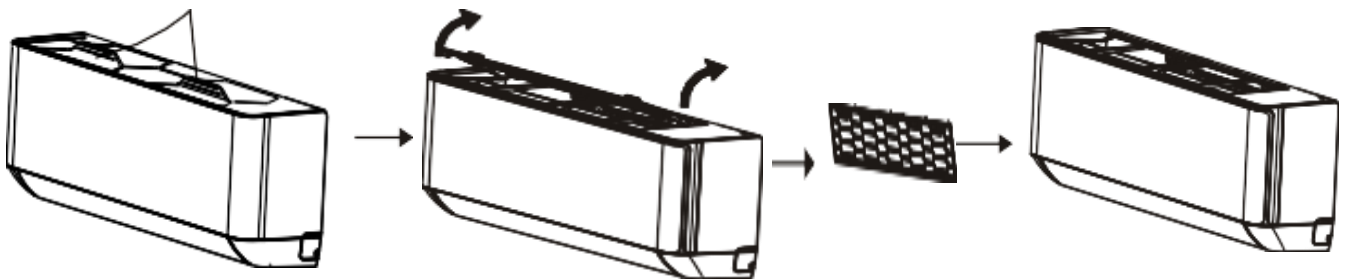

CLEANING OF THE AIR FILTER

Following removal of the air filter following the steps above, it should be cleaned in warm soapy water (<40°C).

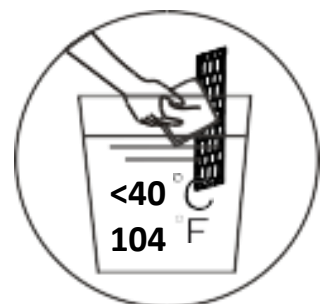

CLEANING AND MAINTENANCE

INTERNAL CLEANING OF THE AIR CONDITIONER

- First, loosen the clip on the middle of louver and bend the louver outwards to take it out.
- Then, grasp both sides of bottom plate push downwards to take down the bottom plate.
- Finally, loosen the buckle of louvre assembly with your thumb and take it out.
- Wipe the air duct and fan assembly with a clean and wrung wet rag.
- Clean the removed parts with soapy water and air dry it. After cleaning, restore the removed parts in turn.

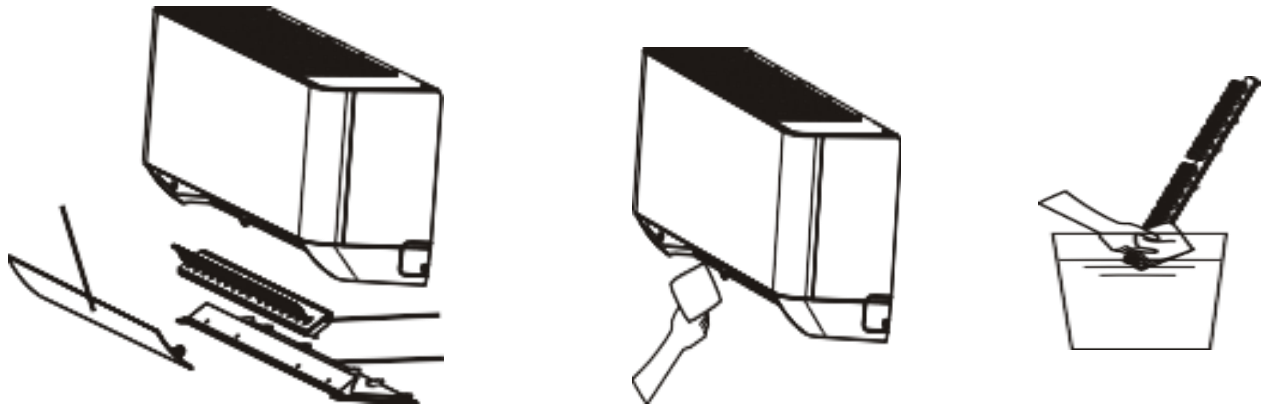

END OF SEASON MAINTENANCE

If the air conditioner is not going to be used for an extended period:

- Use the Self-Clean mode or set the air conditioner to fan mode on a slightly warm day so that the inside of the appliance dries out.
- Switch off the power at the fuse box and remove the batteries from the remote control.
- Clean the filters.

START OF SEASON PREPARATION

If the air conditioner is to be used again after an extended period:

- Check that the air intake and exhaust openings of the interior and exterior units are not blocked. Remove any dirt or debris that has accumulated.
- Check that the filter is installed within the indoor unit and is clean.
- Check that the condensation outlet drains properly and there is no dirt or organic blockage (otherwise leakage may occur).
- Install 2 AAA batteries in the remote control.
- Turn the appliance on, set the time and desired setting.

REPLACING THE BATTERIES

- Remove the cover from the rear of the remote control.
- Replace the AAA batteries, ensuring the correct polarity.
- Reinstall the cover on the rear of the remote control.

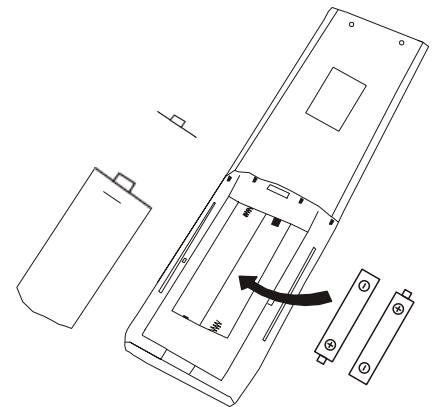

TROUBLESHOOTING AND SELF DIAGNOSIS

MALFUNCTION	POSSIBLE CAUSE
The appliance does not operate	Power failure
	Damaged indoor/outdoor unit fan motor
	Faulty compressor thermomagnetic circuit breaker
	Faulty protective device or fuses
	Loose connections
	Self-protection in adverse conditions
	Voltage higher / lower than the voltage range
	Active TIMER-ON function
	Damaged electronic control board
Strange odour	Air filter dirty
Noise of running water	Back flow of liquid in the refrigerant circulation
A fine mist comes from the air outlet	This occurs when the air in the room becomes very cold, for example in the COOLING or DEHUMIDIFYING modes.
A strange noise can be heard	This noise is made by the expansion or contraction of the front panel due to variations in temperature and does not indicate a problem.
Insufficient airflow, either hot or cold	Inappropriate temperature setting.
	Air inlet or outlet of indoor or outdoor unit has been blocked.
	Air filter is blocked.
	Fan speed set at minimum.
	Other sources of heat in the room.
	No refrigerant.
The appliance does not respond to commands	Remote control is not near enough to indoor unit.
	Battery in Remote controller may have been exhausted.
	Obstacles between remote control and signal receiver in indoor unit.
The display is off	DISPLAY button pressed on remote
	Power failure
Switch off the air conditioner immediately and cut off the power supply in the event of:	
Strange noises during operation.	
Faulty electronic control board	
Faulty fuses or switches.	
Spraying water or objects inside the appliance.	
Overheated cables.	
Very strong smells coming from the appliance.	

TROUBLESHOOTING AND SELF DIAGNOSIS

ERROR SIGNALS ON THE DISPLAY	
In case of error, the display on the indoor unit shown the following error codes:	
Error Code	Failure type
E0	Indoor and outdoor communication failure
EC	Outdoor communication failure
E1	Indoor room temperature sensor
E2	Indoor coil temperature sensor
E3	Outdoor coil temperature sensor
E4	System abnormality
E5	Model configuration wrong
E6	Indoor fan motor fault
E7	Outdoor temperature sensor
E8	Exhaust temp. sensor
E9	IPM drive and module fault
EA	Current sensor fault
Ed	Indoor EEPROM fault
EC	Outdoor Communication fault
EE	Outdoor EEPROM fault
EF	Outdoor fan motor fault (DC motor)
EH	Outdoor suction temperature sensor fault
En	Outdoor gas pipe temperature sensor fault
EP	Temp. switch fault (on top of the compressor)
EU	Voltage sensor fault
Ey	Outdoor liquid pipe temperature sensor fault
Protection Display Code List	
PA	Indoor run mode conflict
P1	Overvoltage /lower voltage protection
P2	Overcurrent protection
P4	Exhaust over temperature protection
P5	Too cool protection in cooling mode
P6	Overheat protection in cooling mode
P7	Overheat protection in heating mode
P8	Outdoor over temperature / lower temperature protection
P9	Drive protection (software control)
P0	Module protection (hardware control)

TROUBLESHOOTING AND SELF DIAGNOSIS

OUTDOOR UNIT FAULT CODES

The outdoor unit has an LED on the power board. This LED will be illuminated when the compressor is running and blink 1s on and 1s off when the compressor is in standby. If there is a fault on the outdoor unit, it will blink on and off for half a second at a time, followed by a 3s gap. The number of consecutive blinks will show the fault as per the table below:

No. of blinks	Fault
1	IPM protection
2	Over voltage /lower voltage
3	Overcurrent
4	Exhaust over temperature protection
5	Outdoor coil over temperature protection
6	Drive fault and protection (V1, VP1)
7	Communication fault with indoor unit
8	Compressor overheat fault (compressor top switch)
9	Short-circuit / open-circuit fault of outdoor temperature sensor
10	Short circuit / open-circuit fault of outdoor heat exchanger temperature sensor
11	Short-circuit / open-circuit fault of exhaust temperature sensor
12	Voltage sensor fault
13	Current sensor fault
14	IPM fault
15	Communication fault between power source board and IPM
16	No feedback from DC fan motor(outdoor unit)
17	Defrost state

WIFI CONTROL TROUBLESHOOTING

Description	Possible Cause
Air conditioner can't be configured successfully	<ol style="list-style-type: none"> 1. Check the mobile device is connected to WIFI 2. Check the AC is connected 3. Check that any firewall or other restrictions are causing problems 4. Check the router is functioning normally 5. Check that the router isn't blocking the App
Mobile device can't control the air conditioner	The app displays "Identification failed". This indicates that the AC has been reset and the mobile device has lost contact with the AC. Reconnect the device following the above instructions. If this fails, delete the AC from your devices list and start the install process from the beginning.
Mobile device can't find AC	<p>The app displays "Air conditioner out of line". Check the below:</p> <ol style="list-style-type: none"> 1. The AC has been reconfigured 2. The AC is not receiving power 3. The router is not powered on 4. The AC can't connect to router 5. The AC can't connect to network through the router 6. The mobile device can't connect to the router 7. The mobile device can't connect to a network (when being used remotely)

TECHNICAL SPECIFICATION

Model		iQool28	
Rated voltage and frequency (Ph-V-Hz)		220-240V~/50Hz	
Fuse Required		20A	
Mode		Cooling	Heating
Rated capacity (W)		8210 (2010~9100)	8300 (2040~9200)
Power input (W)		2727 (500~2930)	2569 (560~3110)
Current input (A)		12.0 (2.7~16)	11.4 (2.7~17)
SEER/SCOP(W/W)		6.5 (A++)	4.0 (A+)
Nominal load (kW)		8.2	8.3
Balance point temperature heating (°C)		/	-7
Min. outdoor operating temperature (°C)		/	-15
Thermostat-off mode (W)		2	
Standby mode (W)		5	
Off mode (W)		2	
Annual consumption (kW)		442	2100
Copper Pipe Type length		5	
Liquid side / Gas side (mm/inch)		12.7 (1/2) + 6.35 (1/4)	
Max. refrigerant pipe length		15m	
Max. elevation		5m	
Interconnecting Cable		5×1.5mm ²	
Moisture Removal (L/h)		3	
Indoor	Air Flow (m ³ /h)	1200	
	Dimensions (L*W*H) (mm)	1100 x 333 x 222	
	Packaging (L*W*H) (mm)	1165×405×295	
	Net / Gross weight (Kg)	14 / 17	
	Noise – Sound pressure level (dB/A)	48	
	Noise – Sound power level (dB/A)	40 - 52	
Outdoor	Dimension (L*W*H) (mm)	967×421×803	
	Packaging (L*W*H) (mm)	1022×480×835	
	Net / Gross Weight (Kg)	47 / 50	
	Noise – Sound pressure level (dB/A)	59	
	Noise – Sound power level (dB/A)	69	
	Refrigerant type/weight	R32 / 1.27kg 	
	Defrost mode	Automatic defrosting	
	Applicable climate types	Cooling (15°C – 53°C) Heating (-20°C – 30°C)	

Due to continuous product development process specification may change

SUPPORT

electriQ UK SUPPORT

Please, for your own convenience, check the troubleshooting guide before calling the service line.

Support@electriQ.co.uk

0330 390 3061

Office hours: 9AM - 5PM Monday to Friday

www.electriQ.co.uk

Unit 2A, Trident Business Park,

Neptune Way, Leeds Road, Huddersfield, HD2 1UA

EU DECLARATION OF CONFORMITY

Hereby, electriQ declares that these air conditioners are in compliance with Directive 2014/53/EU. The full text of the EU declaration of conformity is available at the following internet addresses:

<https://www.electriq.co.uk/DOC/EU/iQool28.pdf>

UK DECLARATION OF CONFORMITY

Hereby, electriQ declares that these air conditioners are in compliance with Radio Equipment Regulations 2017. The full text of the UK declaration of conformity is available at the following internet addresses:

<https://www.electriq.co.uk/DOC/UK/iQool28.pdf>



Disposal: Do not dispose this product as unsorted municipal waste. Collection of such waste must be handled separately as special treatment is necessary.

Recycling facilities are now available for all customers at which you can deposit your old electrical products. Customers will be able to take any old electrical equipment to participating sites run by their local councils. Please remember that this equipment will be further handled during the recycling process, so please be considerate when depositing your equipment. Please contact the local council for details of your local household waste recycling centres.

SUPPORT

WARRANTY INFORMATION

electriQ guarantee provides cover against material or manufacturing faults. This means that if your air conditioner develops a fault within the first 2 years, we will arrange for it to be repaired or replaced*. We will also provide replacement parts within the first 5 years.

The system must be installed and annually serviced by an F-gas registered engineer. Evidence of this must be provided when the fault is logged with our technical team. Faults arising from installation errors and/or damage are specifically excluded.

Where we are unable to confirm that a fault is related to a manufacturing fault, we reserve the right to make a charge to cover the costs of an engineer visit to assess and repair the unit. This charge will be refunded in full if the fault is confirmed to be due to a manufacturing fault.

This unit must be operated under conditions as recommended in this user manual, at voltages indicated on the unit. Any attempts made to service or modify the unit by unqualified person, will render this WARRANTY VOID.

This warranty is in addition to, and does not affect, your statutory rights.

* A replacement may be offered where electriQ deem a repair not to be viable.

We recommend that you note the details of your purchase below and retain your original proof of purchase receipt with this manual. Keep these documents safe in the event of a warranty claim.

Purchase Date:	
Retailer name:	
Model number:	
Serial number:	
Installation Date:	
Installer name:	
Engineer/ Company name:	
Engineers Registration Number	
Service Dates	