

electriQ

USER AND INSTALLATION MANUAL

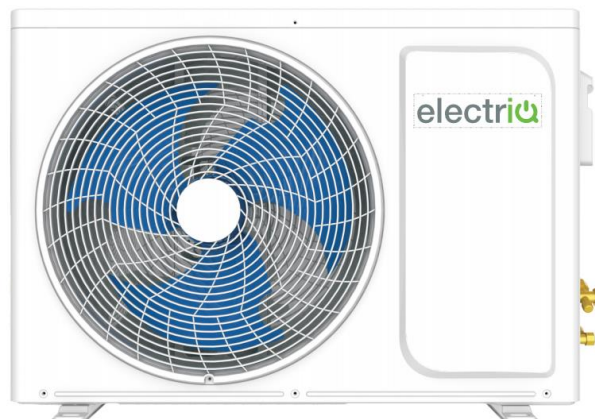
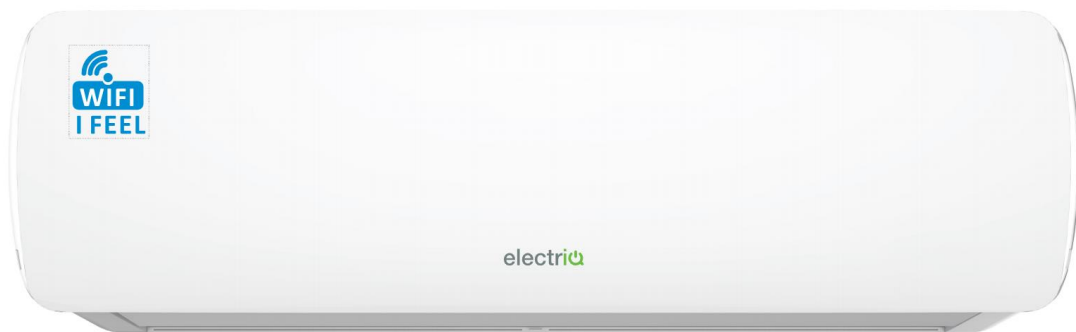

iQool9PLUS-V2 9,000 BTU
iQool12PLUS-V2 12,000 BTU

SMART WIFI CONTROLLED WALL MOUNTED INVERTER SPLIT AIR CONDITIONER WITH HEAT PUMP

Thank you for choosing an electriQ Air Conditioner
Please read this user manual before using this innovative
Air Conditioner and keep it safe for future reference.

SETTLING IN OK?

We hope this has been helpful to you.

We would love to see how you're getting on with your new purchase, so please share any snaps you have on the platform of your choice below.

Our community awaits your uploads - Snap, tag and hashtag away!



@electriQUK

#electriQUK

WE'RE HERE TO HELP

Should you have any problems or questions with your purchase, please contact a member of our customer service team.

☎ 0330 390 3061

✉ support@electriQ.co.uk

Mon-Fri | 9am to 5pm

Unit J6, Lowfields Business Park,
Lowfields Way, Elland
West Yorkshire, HX5 9DA

CONTENTS

SAFETY INSTRUCTIONS	4
OPERATION	6
INDOOR UNIT	7
OUTDOOR UNIT	7
REMOTE CONTROL	8
DISPLAY PANEL	10
FUNCTIONS	11
WIFI CONTROL	14
SETTING UP THE APP	14
CONNECTING THE AIR CONDITIONER	17
USING THE APP	19
MAINTENANCE	24
END OF SEASON	25
START OF SEASON	25
REPLACING THE BATTERIES	25
INSTALLATION GUIDE	26
TOOLS RECOMMENDED FOR INSTALLATION	29
INFORMATION REGARDING THE INSTALLATION OF THE INDOOR UNIT	31
INSTALLATION OF THE OUTDOOR UNIT	32
CONDENSATE DRAINAGE OF THE OUTDOOR UNIT	32
INSTALL THE WATER DRAINAGE PIPE	34
ELECTRICAL CONNECTION OF THE AIR CONDITIONER	36
TROUBLESHOOTING AND SELF DIAGNOSIS	36
WIFI CONTROL TROUBLESHOOTING	37
TECHNICAL SPECIFICATION	41
SUPPORT	42

SAFETY INSTRUCTIONS

IMPORTANT!

- Carefully read the instructions before operating the unit
- This appliance comprises of an indoor and an outdoor unit. The indoor slim evaporator is designed exclusively for indoor installations while the external condenser can be installed outside while still away from flood water or snow line.
- Always place the unit on a dry and stable surface. Install the outdoor unit on a wall with wall-mounting brackets or fix to a floor slab with special floor mounting slab bolts or brackets away from flood or snow lines.
- Rating: This unit must be only connected to a 220-240 V / 50 Hz earthed power source.
- Installation must be in accordance with the regulations of the country where the unit is used.
- This appliance is intended for permanent installation into a fixed structure, and should not be installed on vehicles.
- The outdoor part of the air conditioner unit must always be stored and transported upright, otherwise irreparable damage may be caused to the compressor; if in doubt we suggest waiting at least 24 hours before starting the unit.
- These air conditioners are supplied with pre flared refrigeration pipes and electrical cables, which enables the installer to reduce the installation time.
- European Union regulations requires for an F-Gas trained engineer to handle any operation where non-qualified intervention could cause fluorinated gas to escape. A commissioning certificate must be issued with any installation.
- This air conditioner contains R32 which is a safe efficient refrigerant which has a lower environmental burden than traditional refrigerants.
- The refrigerant used in this air conditioner is an environmentally friendly hydrocarbon R32, which has a very low Global Warming Potential compared to traditional refrigerants.
- R32 is classed as slightly flammable and as such naked flames and sources of ignition should be kept a safe distance from the unit.
- If you are in any doubt about the suitability of your electrical supply have it checked and, if necessary, modified by a qualified electrician.
- This air conditioner has been tested and is safe to use. However, as with any electrical appliance - use it with care.
- Disconnect the power before dismantling, assembling or cleaning.
- Never connect the unit to an electrical outlet using an extension cord. Both the indoor unit and outdoor must be hardwired by a qualified electrician.
- Never operate this appliance if the cord is damaged. Ensure the power cord is not stretched or exposed to sharp objects or edges.
- A damaged supply cord should be replaced by the manufacturer or a qualified electrician in order to avoid a hazard.
- Avoid touching any moving parts within the appliance.
- Never insert fingers, pencils or any other objects through the guard
- This appliance is not intended for use by persons (including children) with reduced physical, sensory or mental capabilities. It is also not intended for use by those with a lack of experience and knowledge, unless they have been given supervision or instruction concerning the use of the appliance by a person responsible for their safety. Do not leave children unsupervised with this appliance.
- Do not clean the unit by spraying it or immersing it in water.
- Any service other than regular cleaning

SAFETY INSTRUCTIONS

or filter replacement should be performed by an authorized service representative or a qualified air conditioning engineer. Failure to comply could result in a voided warranty.

- This air conditioner is intended for cooling / heating a room to a suitable level for human comfort, and should not be used for any other purpose such as cooling food.
- Avoid restarting the air conditioning unit unless 3 minutes have passed since being turned off. This prevents damage to the compressor.
- Never use the mains as a switch to start and turn off the air conditioning unit. Use the provided ON/OFF button located on the remote control.
- The indoor unit should not be installed in laundry or wet rooms.
- Diagrams and pictures provided within the manual are for guidance only. Due to continual product development, if there is any variance between the manual and the product received, the information provided on the product should be followed.

ENERGY SAVING AND UNIT SAFETY PROTECTION TIPS

- Do not cover or restrict the airflow from the outlet or inlet grills.
- For maximum performance the minimum distance from a wall or objects should be 50cm.
- Keep the filters clean. Under normal conditions, filters should only need cleaning once every four weeks (approximately). Since the filters remove airborne particles, more frequent cleaning maybe necessary, depending on the air quality.
- For the initial startup set the fan speed to maximum and the thermostat to 4-5 degrees lower than the current temperature. After, set the fan switch to low and set the thermostat to your desired setting.
- To protect the unit we recommend not using the cooling mode when the ambient indoor temperature is higher than 35°C.
- To protect the unit we recommend not using the heating mode when the indoor ambient temperature is lower than 7°C. Performance will be reduced at lower temperatures.
- Note the manufacturer operating temperature ranges at the end of this user manual.

OPERATION

COOLING MODE

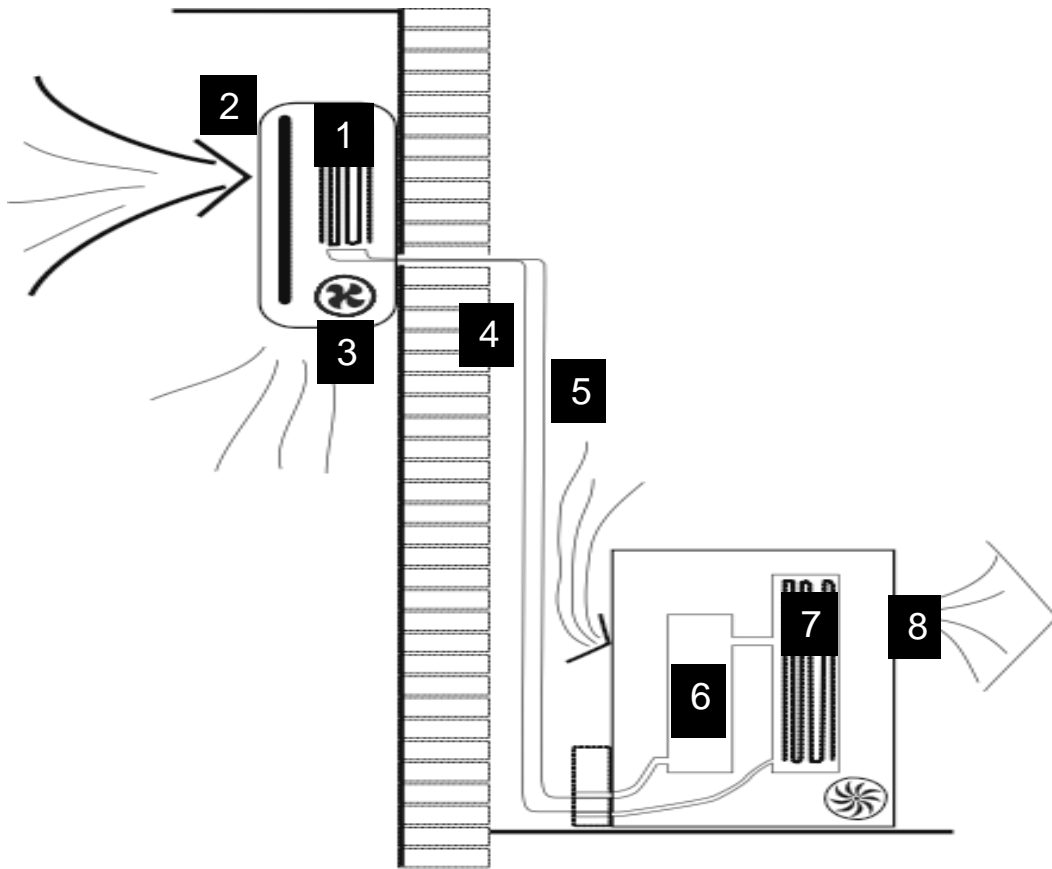

The compressor (6) in the external unit compresses the refrigerant into a high-temperature, high-pressure gas. When this gas flows along the cooling fins of the condenser (7), heat is exuded and the gas condenses into a liquid, which is then led to the evaporator (1) in the indoor unit. The liquid expands into a gas at a low temperature and low pressure. This gas absorbs the warmth of the air in the room, and a fan (3) draws the air through the filter and over the evaporator (1), blowing the cooled air back into the room. The heat is moved to the compressor along with the gas. A fan (8) draws air over the condenser and blows the warm air away.

- | | | |
|---------------|------------------|-------------------|
| 1. Evaporator | 2. Filter | 3. Evaporator Fan |
| 4. Gas Line | 5. Liquid line | 6. Compressor |
| 7. Condenser | 8. Condenser Fan | |

HEAT PUMP MODE

The system operates in reverse: the condenser works as an evaporator, the evaporator as a condenser: warm air is blown into the room. It is ideal as a maintenance heating when outside temperature is not too low and when the indoor temperature is more than 7°C.

DEHUMIDIFYING

As with cooling, the moisture in the air condenses on the cold evaporator at room temperature acting as a powerful dehumidifier.

OPERATION

INDOOR UNIT

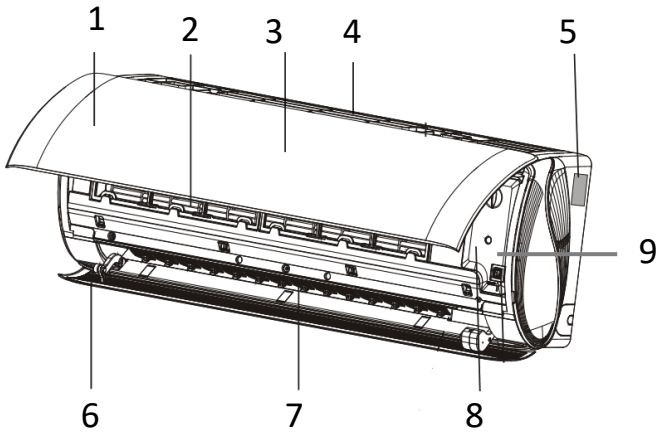

No.	Description
1	Front panel
2	Air filter
3	LED display
4	Air Inlet
5	Rating Label
6	Louvre
7	Deflectors
8	Connectors
8	Reset button

Note: Diagrams are for illustrative purposes only and there may be variations between the diagram and actual product.

OUTDOOR UNIT

No.	Description
9	Air outlet grille
10	Terminal block cover
11	Gas valve
12	Liquid valve

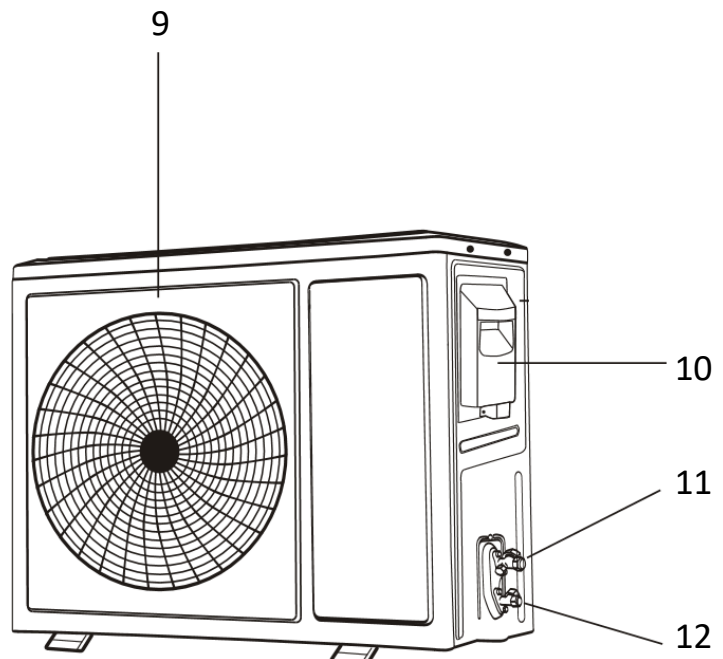

OPERATION

REMOTE CONTROL

The remote control has a range of up to 8m. Point the remote control at the receiver in the interior unit. A beep confirms that the remote control signal has been received.





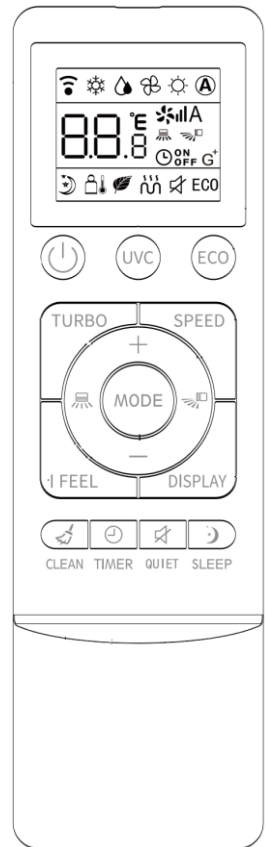

REMOTE OPERATION

Turn the appliance on using the **ON/OFF** button. This activates the most recently used setting.

The ON/OFF button also turns the air conditioner off.



BUTTONS

Button	Function
	Press to turn the unit on or off.
MODE	Press to change between the different modes: Auto, Cool, Heat Dry and Fan.
TURBO	Press to activate turbo mode. This will make the unit work in high performance mode to quickly cool or heat the room for a period of 15 minutes. The fan will be set to max, the temperature will be set to either 16°C in cooling mode or 31°C in heating mode.
SPEED	Press to select the fan speed between LOW, MED and HIGH.
I FEEL	Press to activate the follow me function, where the room temperature is measured on the remote control, rather than within the indoor unit.
DISPLAY	Press while the air conditioner is running to turn the display on and off.
+	Press to increase the desired room temperature or adjust the timer duration.
-	Press to decrease the desired room temperature or adjust the timer duration.
	Press to turn vertical swing on and off
	Press to turn horizontal swing on and off
UVC	Press to turn the optional UVC sterilisation function on and off
ECO	Eco mode: Use in heating and cooling modes to reduce energy consumption. In cooling mode eco mode slowly increases the desired temperature by 2°C. In heating mode eco mode slowly decreases the desired temperature by 2°C
	Clean: Press to run the self cleaning function
	Timer: Press to activate the startup / shutdown timer
	Quiet: Press to put the air conditioner in low noise mode
	Sleep: Press to activate the sleep function

OPERATION

DISPLAY

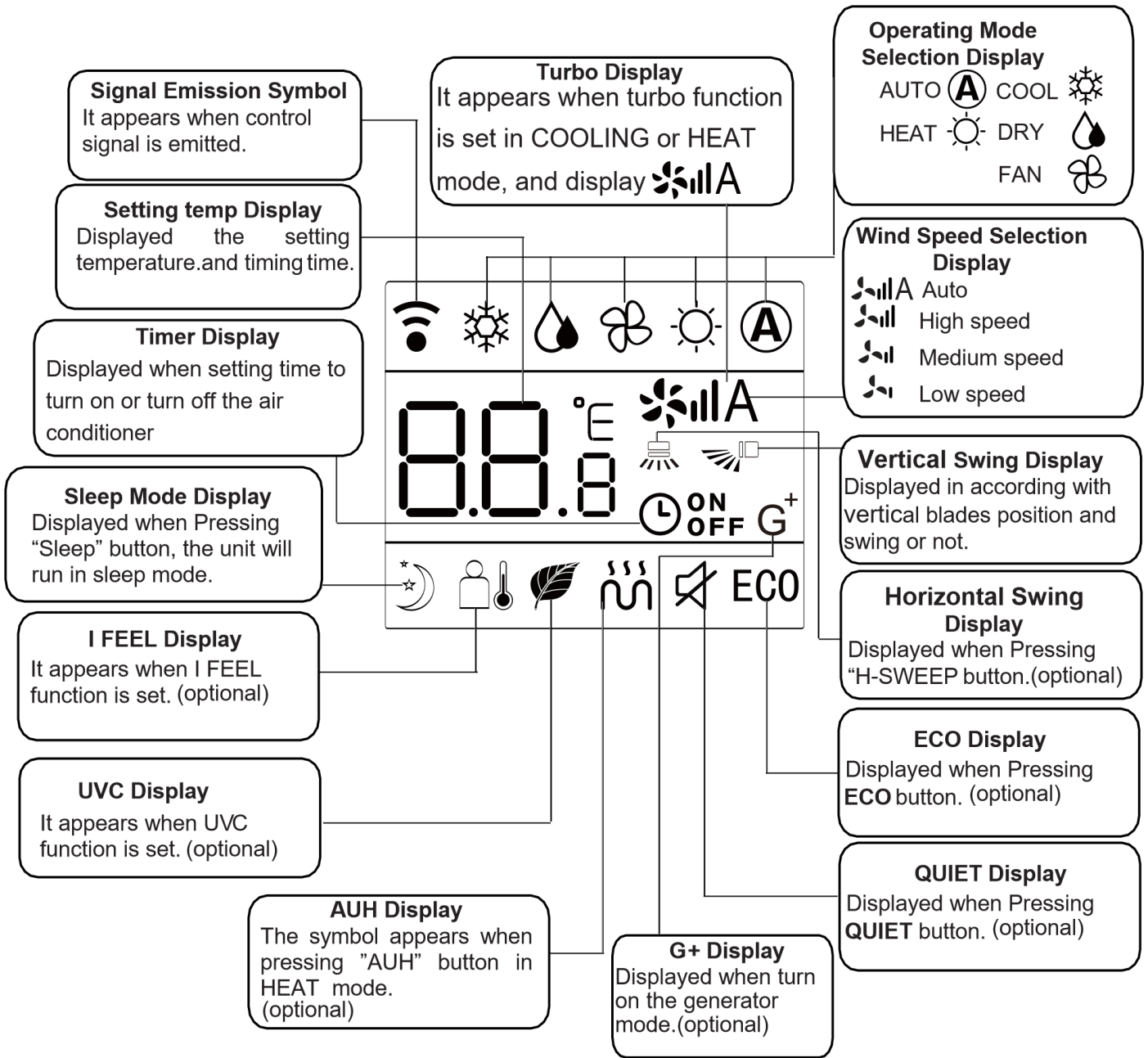

RESET BUTTON

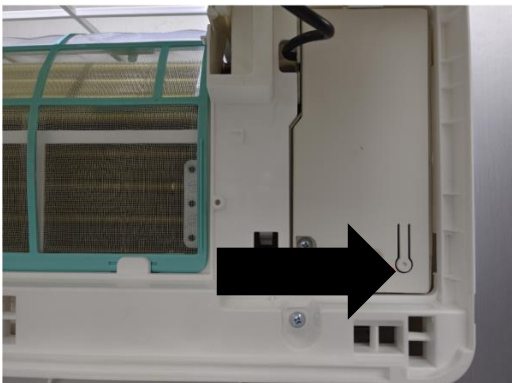

There is a reset button located on the indoor unit which can be pressed to reset the unit.

It is also be pressed and held for 5 seconds to start the WiFi connection mode – see the WiFi section for more details.

OPERATION

TEMPERATURE

The desired temperature is set with the up and/or down button, within the limits of the thermostat: 16°C – 31°C.

Use the **FAN SPEED** button to set the fan speed at low, medium and high; or automatic (the symbol on the display will flash). The fan speed in the automatic setting is determined by the difference between the set temperature and the room temperature.

DISPLAY PANEL

The display panel on the front of the unit will display the desired room temperature and a number of other symbols depending on the features activated.



Health indicator: This light is on when the UVC function or the Cold plasma generator is working.



Timer indicator: This signal light is on when the unit is in Timer.



Compressor indicator: This signal light is on when the compressor is running



WIFI indicator: Flashing on behalf of searching, lighting on behalf of WIFI completed connection, Which means WIFI function can be operation and application.

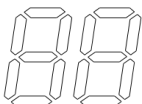

Temperature indicator: This display can show the set temperature .when the indicator display F4,F1 or F2, means the air conditioner runs abnormally

OPERATION

FUNCTIONS

COOL

1. Press the **MODE** button until the **COOL** indicator appears.
2. Set the desired temperature using the + and - buttons.
3. Use the **FAN** button to set the fan speed.

HEAT

1. Press the **MODE** button until the **HEAT** indicator appears
2. Set the desired temperature using the + and - buttons.
3. Use the **SPEED** button to set the fan speed.

FAN MODE

1. Press **MODE** button until the **FAN** indicator appears.
2. The temperature settings are disabled in fan mode.
3. Use the **SPEED** button to set the fan speed, cycling through LOW / MED / HIGH / AUTO.

DRY

1. Press the **MODE** button until the dry indicator appears.
2. The fan speed will always be low in this mode and the **SPEED** button is disabled. In addition the temperature cannot be adjusted in dehumidifying mode

AUTO MODE

1. Press the **MODE** button until the **AUTO** indicator appears.
2. The difference between the set temperature and room temperature determines how the air conditioner operates: cool, heat, fan or dry. It is not possible to change the temperature in this mode the unit will operate to achieve best performance. The operation logic is as below.

Ambient Temperature	Operation Mode	Auto Temperature
<20°C	Heating	23°C
20°C - 26°C	Dry	18°C
>26°C	Cool	23°C

3. Use the **SPEED** button to set the fan speed.

TIMER OFF FUNCTION (WHILE THE AIR CONDITIONER IS ON)

1. Press the **MODE** button until the symbol appears for the operation you want.
2. Set the desired temperature.
3. Use the **SPEED** button to set the fan speed.
4. Press the **TIMER** button to set the running time required. Use the up and down buttons to set the running time (max 24 hours). Once the running time has elapsed, the appliance will switch itself off. To cancel the timer function before the set time has elapsed, press the **TIMER** button again.

TIMER ON FUNCTION (WHILE THE AIR CONDITIONER IS IN STANDBY)

1. The appliance is switched off in standby mode
2. Press the **TIMER** button to set the number of hours until switch on is required. Use the up and down button set the number of hours (max 24 hours). Set the desired operation, temperature, fan speed. Once the set time has elapsed, the appliance will switch itself on. To turn off the timer function before the set time has elapsed, press the **TIMER** button again.

OPERATION



SLEEP MODE

1. Press the **SLEEP** button
2. Set the desired temperature.
3. Press the **SLEEP** button; The **SLEEP** indicator will appear on the display. Cancel the sleep mode by pressing the button again.
4. The fan will operate at low speed.
5. The temperature is automatically altered by 1°C every hour for 2 hours. In cooling mode the desired temperature will rise, in heating it will fall.
6. After 10 hours in Sleep mode the unit will power off automatically.

TURBO

1. Press the **TURBO** button until the Turbo symbol appears.
2. Set the desired temperature.
3. Use the **FAN** button to set the fan speed.
4. Press the **TURBO** button. The fan and compressor will run at maximum speed for 15 minutes, before returning to their previously set levels.

SWING

1. Press the **SWING** buttons to control the fan direction.
2. The  controls the horizontal air movement (up/down).
3. The  controls the vertical air movement (left/right).

ECO

1. Press the **ECO** button to turn on the energy saving mode
2. In cooling mode, the desired temperature will increase by 2°C.
3. In heating mode, the desired temperature will decrease by 2°C.

IFEEL

1. Press the **IFEEL** button to activate the follow me mode.
2. In this mode the temperature of the unit will be set based on the temperature where the remote is situated.
3. The remote will act as a mobile thermostat which controls the unit.

OPERATION

IMPORTANT INFORMATION

HEATING MODE

When the air conditioner is placed in heating mode, the indoor unit will appear to be inactive while it follows its preheat procedure to heat the evaporator coils. Once the coils have heated, the indoor fan will start to run. This process usually takes 1 – 3 minutes, and is designed to ensure that cold air is not circulated.

AUTO RESTART

The air conditioner will automatically restart when electricity is restored after a power cut. If in doubt, check the settings.

RANGE OF INTERNAL THERMOSTAT

The internal thermostat can be set at a desired temperature between 16 and 31°C. Note that whether the desired value is achieved depends on the room size, temperature and insulation of the room.

RANGE OF HEAT PUMP FUNCTION

The heat function can be used when the external ambient temperature is above -15°C. The performance of the heat pump will degrade with lowering external temperatures. Please note the performance will reduce when the outdoor temperature drops below 5°C.

CAPACITY

The required cooling or heating capacity depends greatly on the location and/or use of the room where the air conditioner is installed. Strong sunlight and the presence of people, lights or equipment creates an additional heat load. Normal living spaces require about 350 Btu per square metre of floor surface. In strong sunlight or if other sources of heat are present, this may be as much as 1200 Btu per sqm.

Tip: On warm days, let the air conditioner cool the room as much as possible during the night and keep the temperature constant from night to daytime.

WIFI CONTROL

DOWNLOAD THE APP TO YOUR PHONE

Download the "TUYA SMART" app, from your chosen app store, using the QR codes below, or by searching for the app in your chosen store.

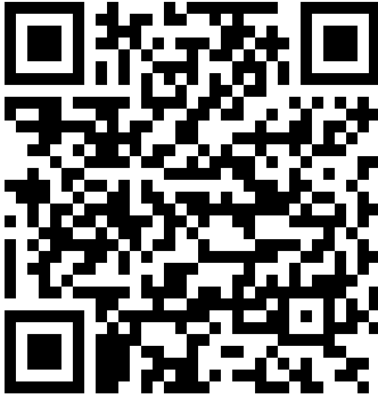

Android



IOS

MODES AVAILABLE FOR SETUP

The air conditioner has two different setup modes, Quick Connection and AP (Access Point). The quick connection is a quick and simple way to set the unit up. The AP connection uses a direct local WiFi connection between your phone and the air conditioner to upload the network details.

To turn the WiFi on press and hold the RESET button on the indoor unit for 5 seconds until the air conditioner bleeps. Alternatively quickly press the DISPLAY button on the remote 6 times. The WiFi symbol will flash quickly to indicate the unit is in quick connection mode

Please ensure your device is in the correct WiFi connection mode for the connection type you are attempting, the flashing WiFi indicator on your air conditioner will indicate this.

Connection Type	Frequency of Flashes
Quick Connection	Flashes three times per second
AP (Access Point)	Flashes three times per two seconds

CHANGING BETWEEN CONNECTION TYPES

If the connection has failed then need change to slowly flash state. When the WIFI indicator is flashing at speed, press and hold the RESET button on the indoor unit for 5 seconds. Alternatively quickly press the DISPLAY button on the remote 6 times and the WIFI indicator will begin to slowly flash.

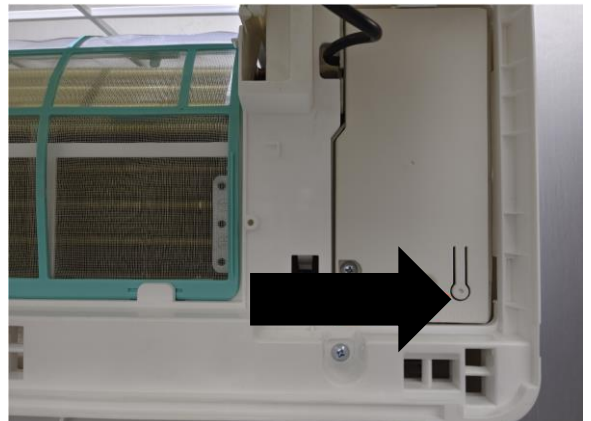

WIFI CONTROL

REGISTER THE APP

1. Press on the register button at the bottom of the screen.

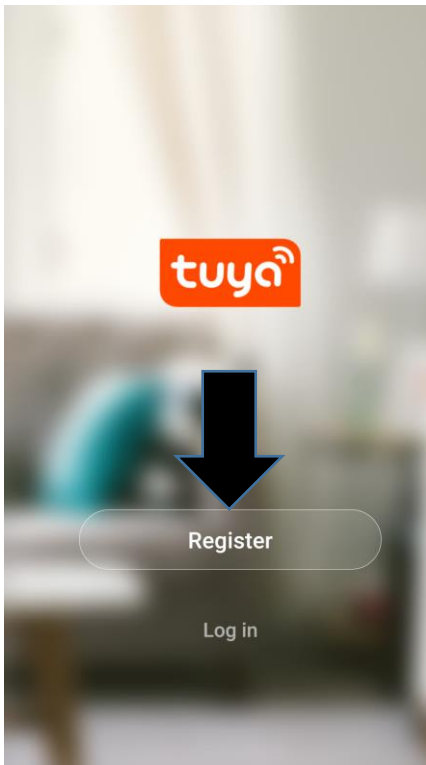

2. Read the Privacy policy and press the Agree Button.

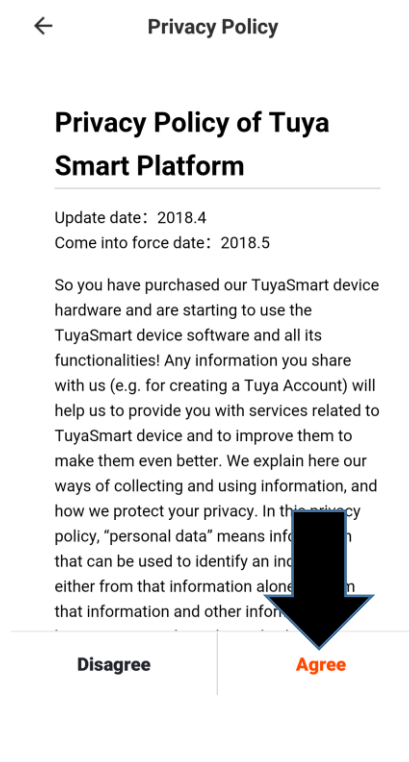

3. Enter your email address or phone number and press continue to register.

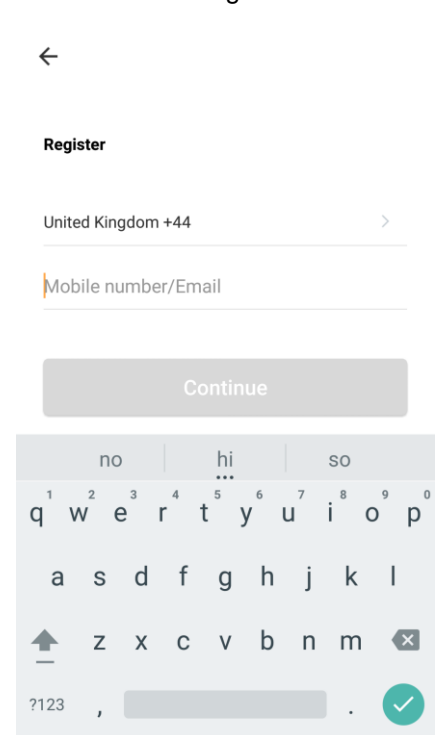

4. A verification code will be sent by the method selected in step 3. Enter the code into the app.

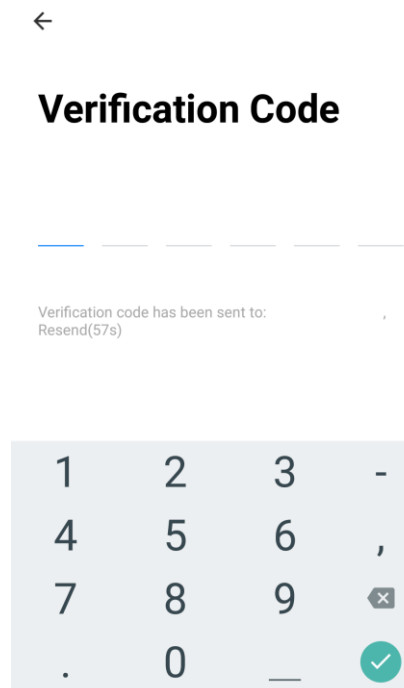

5. Type in the password you would like to create. This needs to be 6-20 characters, with letters and numbers.

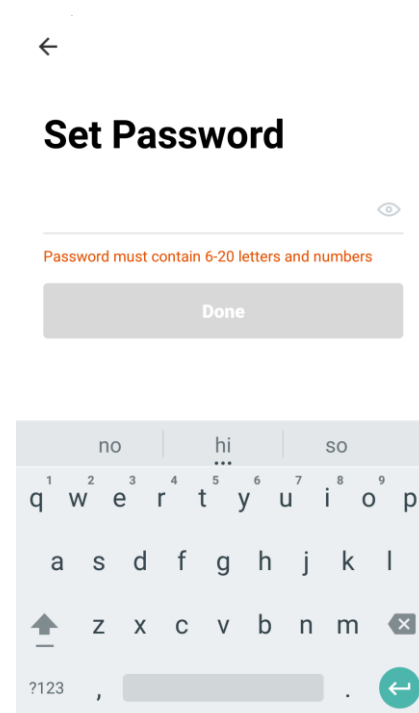

6. The app is now registered. It will automatically log you in following registration.

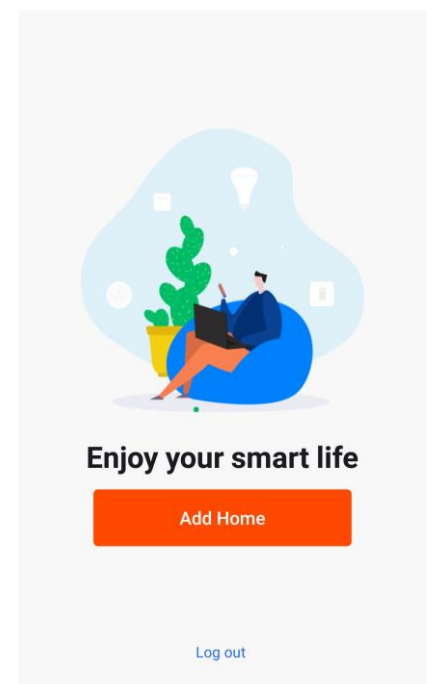

WIFI CONTROL

SETTING UP YOUR HOME WITHIN THE APP

TUYA is designed so it can work with a large number of compatible smart devices within your home. It can also be set up to work with multiple devices within different houses as such during the setup process, the app requires that different areas are created and named to allow easy management of all your devices. When new devices are added, they are assigned to one of the rooms you have created.

CREATING ROOMS

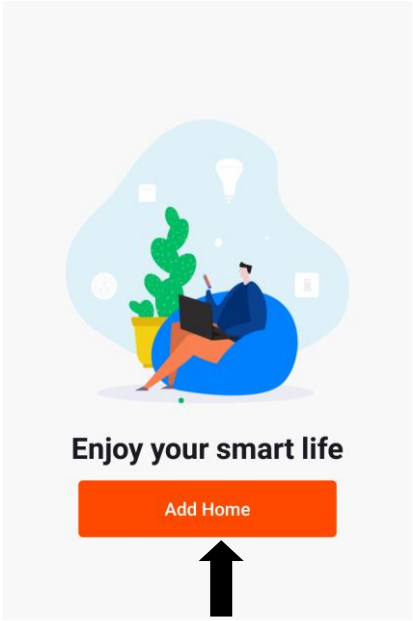
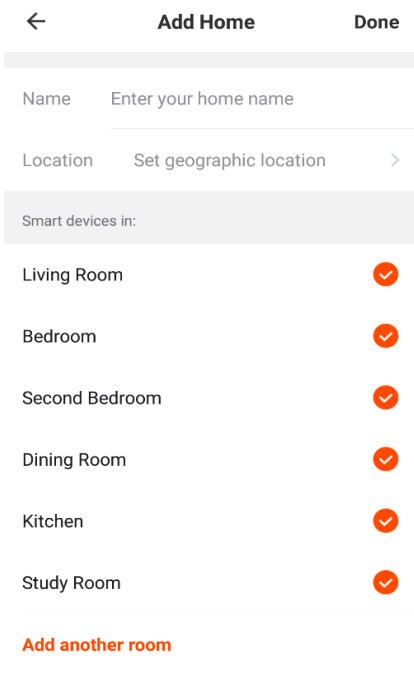
<p>1. Press on the ADD HOME button.</p> 	<p>2. Type in a name for your home, 3. Press on the location button to select the location of your home. (See SETTING YOUR LOCATION below) 4. New rooms can be added by pressing the ADD ANOTHER ROOM option at the bottom. (See ADD ANOTHER ROOM below) 5. Untick any rooms that are not required on the app. 6. Press DONE in the top right corner.</p> 
--	--

SETTING YOUR LOCATION

Use your finger to move the orange HOME symbol.

When the symbol is in the approximate location of your home, press the confirm button in the top right corner.

Location details allows the app to be set up later to respond to weather conditions in your area.

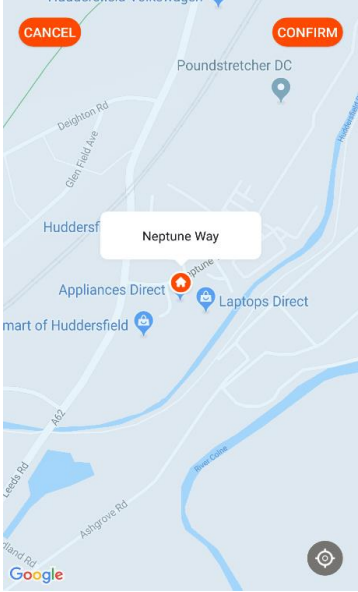

ADD ANOTHER ROOM

Type in the name of the room, and press Done in the top right corner

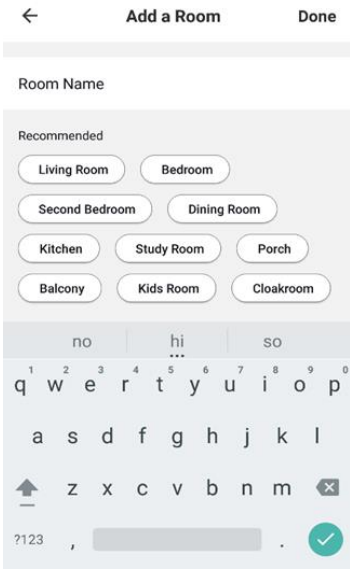

WIFI CONTROL

CONNECTING USING THE QUICK CONNECTION METHOD

Before initiating the connection, make sure the WiFi indicator is flashing twice per second. If not follow the instructions for changing the connection mode. Also ensure your phone is connected to the WiFi network. (We advise turning mobile data off during setup)

1. Open app and press “+” to add device, or use the add device button

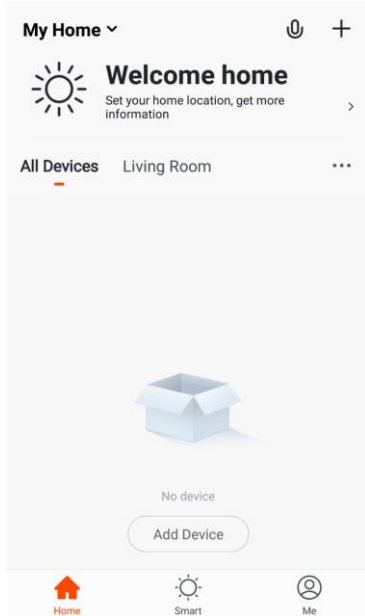

2. Select the type of device as “Air Conditioner (WiFi)” within the Large Home Appliance tab.



3. Press on the orange button at the bottom of the screen.

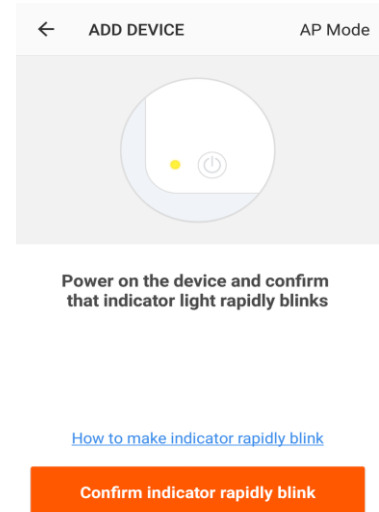

4. Enter your Wi-Fi password and press confirm.

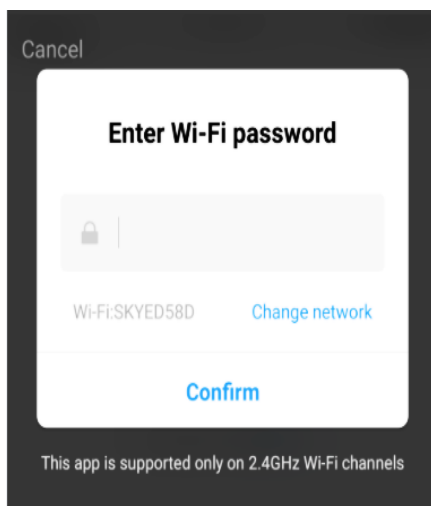

5. This will then transfer the settings to the air conditioner. Wait for this to complete. If this fails, retry.

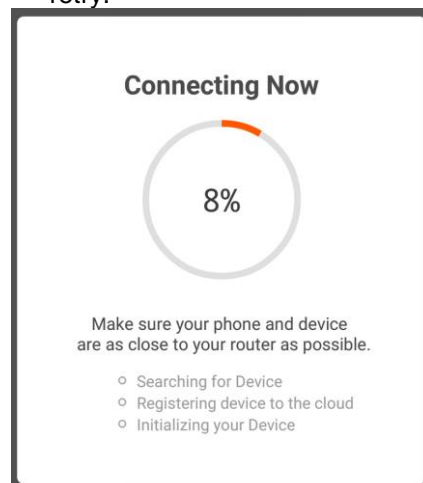

WiFi CONTROL

CONNECTING USING AP MODE (ALTERNATIVE METHOD)

Before initiating the connection, make sure the unit is in standby mode, with the WiFi Indicator flashing once per second. If not follow the instructions for changing the WiFi connection mode. Also ensure your phone is connected to the WiFi network. (We advise turning mobile data off during setup)

1. Open app and press “+” to add device, or use the add device button

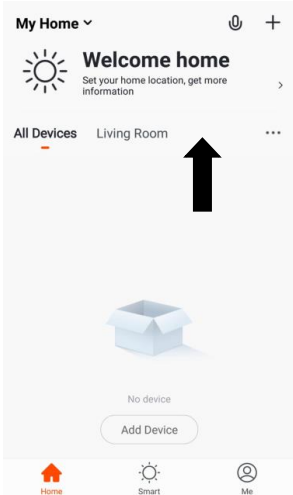

2. Select the type of device as “Air Conditioner (WiFi)” within the Large Home Appliance tab



3. Press on the AP mode button in the top right of the screen.

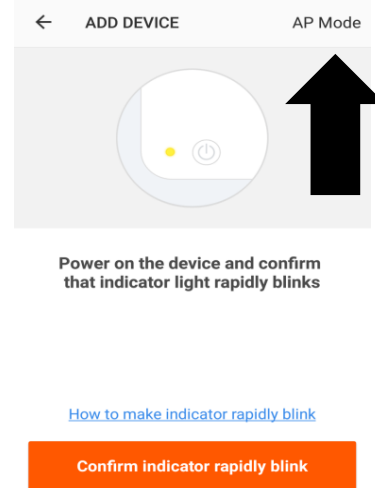

4. Ensure the WiFi indicator on the air conditioner is slowly flashing (once per second), then press on the orange button at the bottom of the screen to confirm

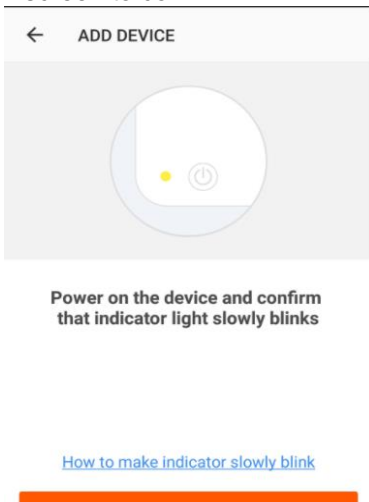

5. Enter your WiFi password and press confirm.

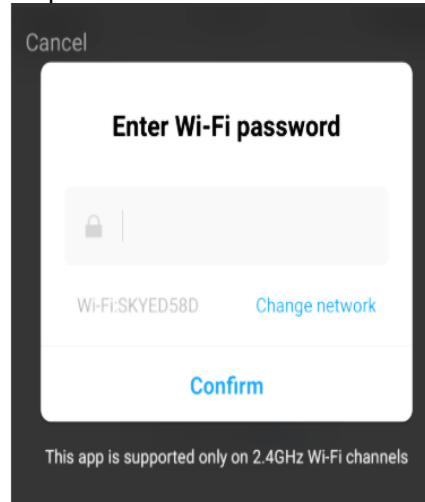

6. Go to network settings in your phone and connect to the “SmartLife xxx” connection. There is no password to enter. Then return back to the app to complete setup.

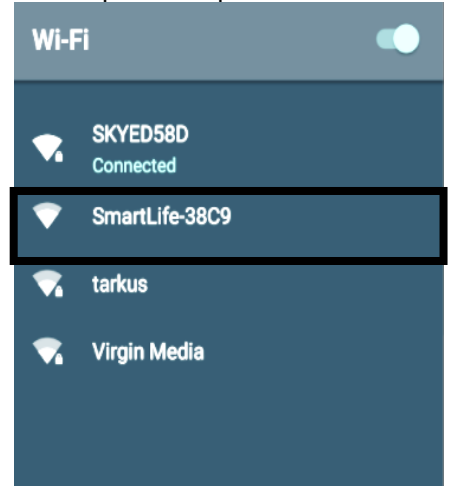

This will then transfer the settings to the air conditioner. Once the connection process has completed, go back to the network settings on your phone to ensure your phone has reconnected to your WiFi router.

WIFI CONTROL

CONTROLLING YOUR APPLIANCE THROUGH THE APP THE HOME SCREEN

NOTE: Due to continuous development of the app, the layout and available features may be subject to change.

Each device has its own entry on the home screen to allow the user to either quickly turn the unit on or off, or to enter the device screen to make other changes.

Voice Control: Press to give verbal instructions for operation.

Add Device: Add a device to the app, and go through the setup process.

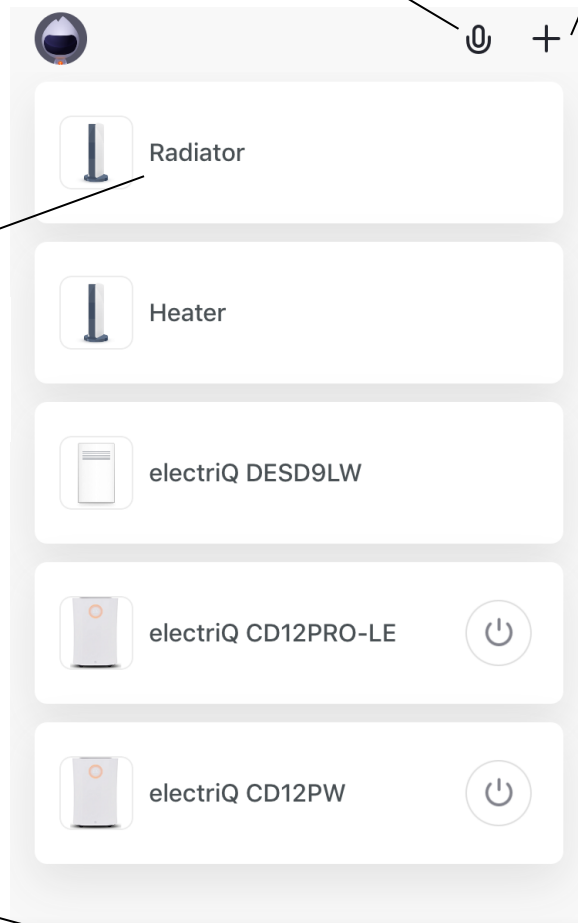

Name of Device: Press to enter the Device Screen.

Home: Return to home screen from the Smart Scene and Profile screens.

Smart Scene: Allows you to program intelligent behaviour based on the internal and external environment.

Profile: Provides the option for changing settings.

WIFI CONTROL

DEVICE SCREEN

The device screen is the main control screen for the air conditioner, providing access to the controls to amend the functions and settings.

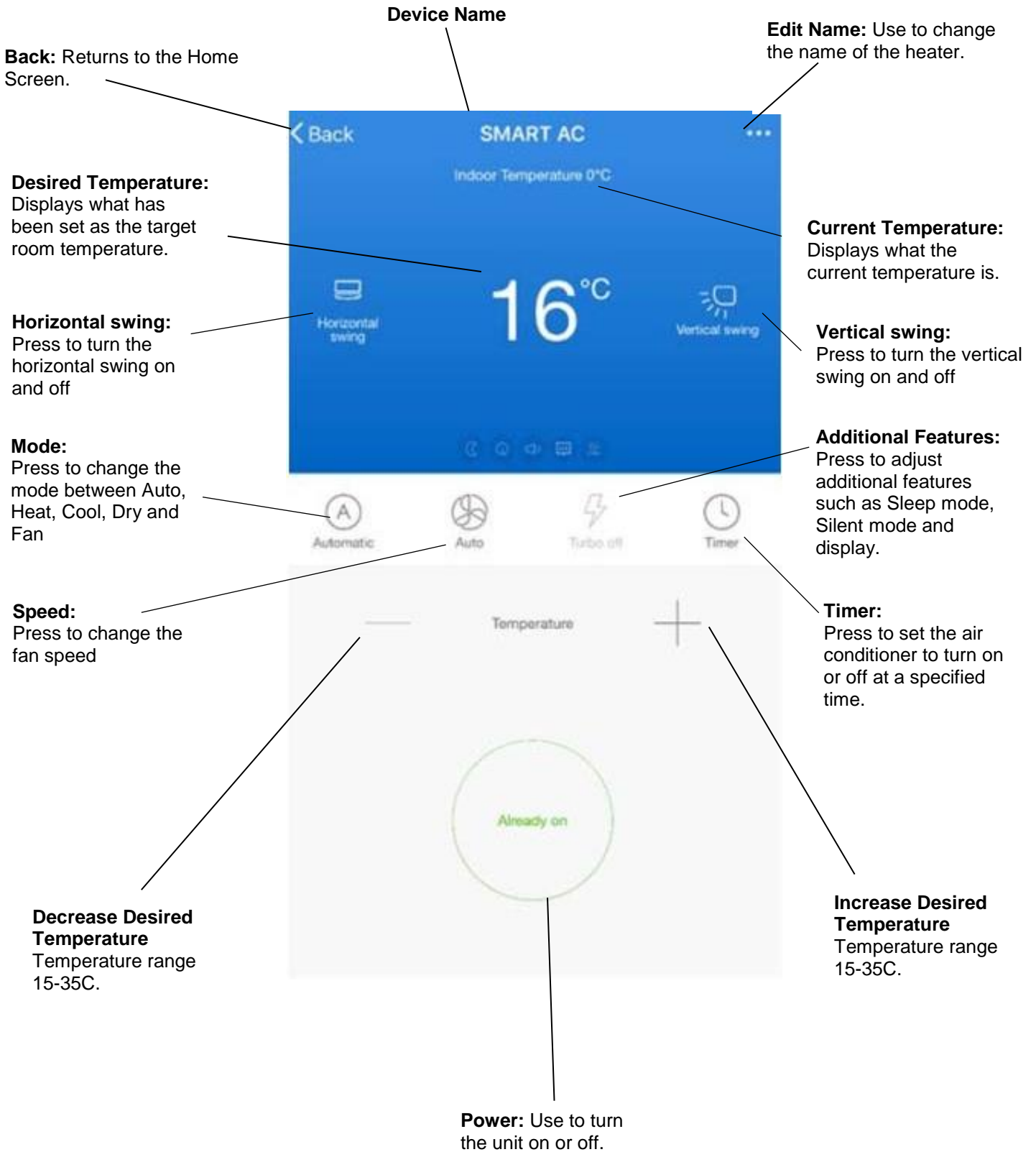

WIFI CONTROL

SMART SCENES

Smart Scenes is a powerful tool providing the option to customize the operation of the air conditioner based both on conditions within the room and outside influences. This gives the user the option of specifying much more intelligent actions. These are split into two categories Scene and Automation.

SCENE

Scene allows for a one touch button to be added to the Home Screen. The button can be used to change a number of settings in one go, and can change all the settings within the unit. A number of scenes can easily be setup, allowing the user to easily change between a number of preset configurations.

Below is an example of how to set up a scene:

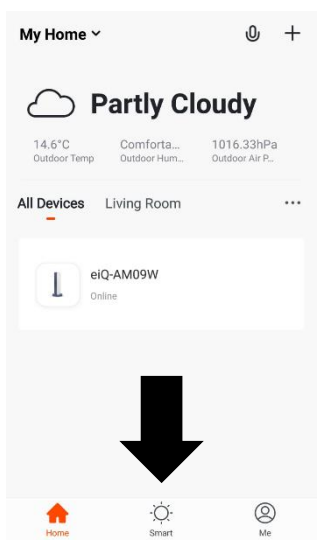
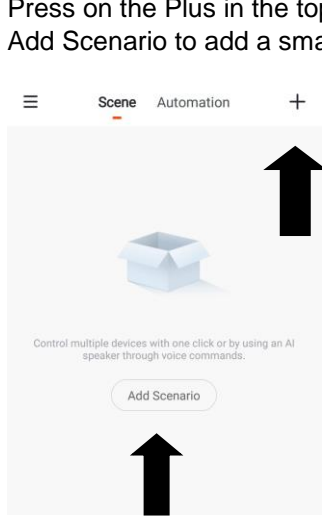
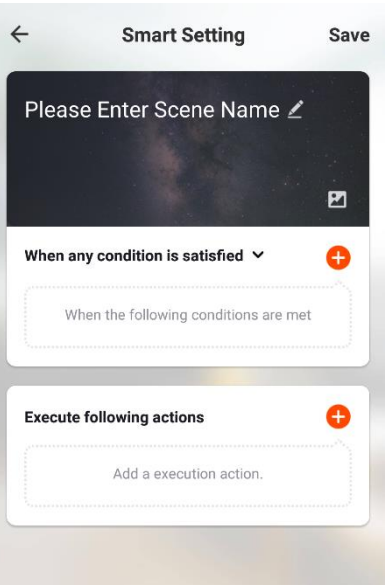
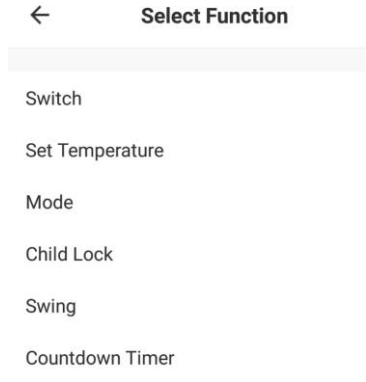
<p>1. Press on the Smart tab at the bottom of the Home screen</p> 	<p>2. Press on the Plus in the top right corner or on Add Scenario to add a smart scene.</p> 	
	<p>3. Press the Pen next to "Please Enter Scene Name" to input the name for your Scene Show on Dashboard: Leave this on if you require the scene to be displayed as a button on the Home Screen Press the Red Plus to add the action required. Then select the air conditioner from the list of devices.</p>	<p>4. Chose the function, set the value for the function, and then press the back button in the top right corner, to return to the previous screen.</p> 
<p>6. Once all the functions required have been added, press the Save button in the top right corner to finalize and save your new Scene. It will then be saved to the home screen</p>		

WIFI CONTROL

AUTOMATION

Automation allows an automatic action to be set up for the device. This can be triggered by the Time, and a range of other influences, depending what other TUYA enabled devices you have on the network.

1. Press on the Scene tab at the bottom of the Home screen

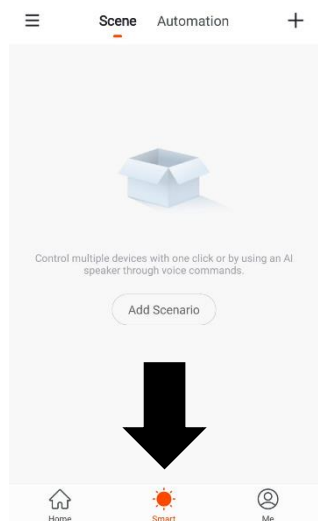

2. Press on the Automation tab at the top of the screen.

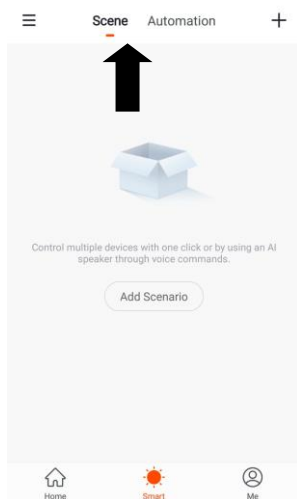

3. Press on the + at the top of the screen or press on Add Automatic Action

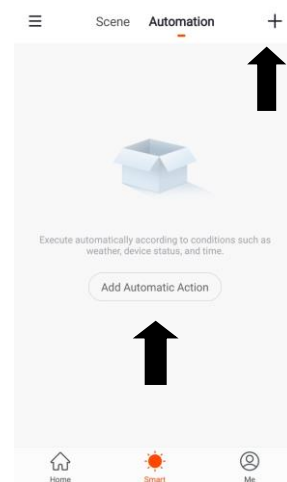

← Select Function

- Switch >
- Set Temperature >
- Mode >
- Child Lock >
- Swing >

4. Setup is very similar to the scene setup on the previous page, and includes an extra section for specifying a trigger for the scene to start. Press the Pen next to "Please Enter Scene Name" to input the name for your Scene Press the Red Plus next to "When any condition is satisfied" to add the trigger Press the Red Plus next to "Execute following actions" to add the action required. Then select the air conditioner from the list of devices.

5. Select the condition when the automation should start. A number of triggers can be combined.

← Select Function

- Switch >
- Set Temperature >
- Mode >
- Child Lock >
- Swing >
- Countdown Timer >

6. Chose the function, set the value for the function, and then press the back button in the top right corner, to return to the previous screen.

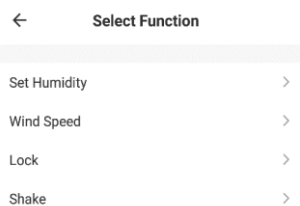

7. Once all the functions required have been added, press the Save button in the top right corner to finalize and save your new scene.

The automation is now set up, it can be turned on and off using the toggle on the home page.

WIFI CONTROL



PROFILE TAB

The profile tab gives you the option to edit both your detail, and use the added features of the unit.



Click here to set ni... >

HOME MANAGEMENT

Home Management provides options for managing your TUYA account, giving options such as adding a home, adding and removing rooms, and sharing devices with family.

Home Management >

Message Center >

Help Center >

More Services >

Settings >

MESSAGE CENTRE

View notifications from devices, if alarms are set up (dependent on device).

HELP CENTRE

Provides assistance using the features provided within the app.

MORE SERVICES

This allows the unit to be integrated with your favorite home automation hardware such as Google Home and the Amazon Echo.



Home



Smart



Me

CONNECTION TROUBLESHOOTING

1. Check whether the device is powered on and is in the correct WiFi connection mode, if not please refer to the CHANGING BETWEEN CONNECTION MODES section.
2. Ensure the WiFi password has been entered into the app correctly (Case sensitive)
3. Check that the phone is connected to the WiFi you are connecting the device to.
4. Ensure the network you are connecting it to is 2.4Ghz (5Ghz WiFi networks are not supported), and that there is a strong WiFi signal to the item.
5. If your router is dual band, ensure that the 2.4ghz network has a different network name (SSID). Further advice on changing router settings will be available from your Internet service provider / Router manufacturer.
6. Check the settings on the router. Encryption should be WPA2-PSK and authorisation type should be set to AES
7. Try using the alternative connection method. i.e. If connection is failing when attempting to connect through CF mode, try AP mode.

MAINTENANCE

FILTERS

Ensure the power is turned off to the unit before attempting to service the filters.

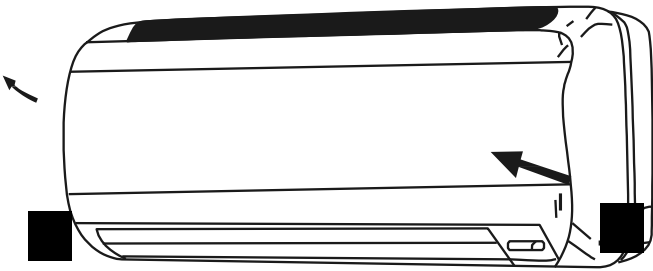

OPENING THE FRONT PANEL: At the recesses, pull the front part up with both hands. The front panel will stay horizontal (at around 90°).

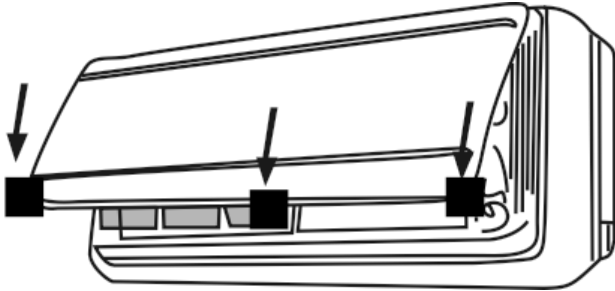

CLOSING THE FRONT PANEL: Press the front part down at the sides and in the middle. Make sure it is properly clicks into place.

REMOVING AND REPLACING THE FILTERS

1. Hold the front panel open (or put it in horizontal position) and remove the filter(s).
2. Use a vacuum cleaner to remove dirt. If the dust filter is very dirty, it may be washed in lukewarm water with a very small amount of neutral detergent. Rinse well and allow to dry completely (not in direct sunlight or near a source of heat).

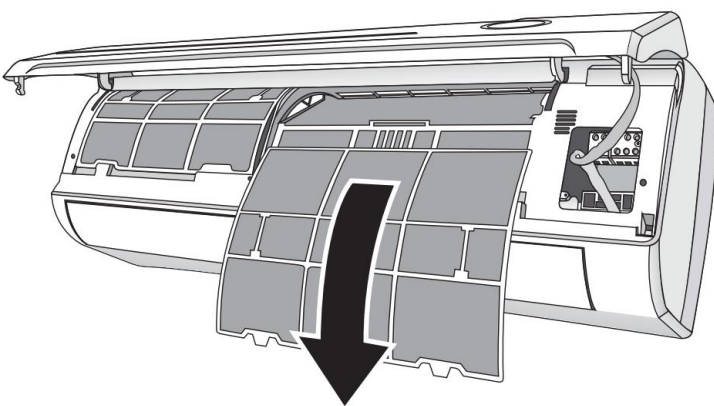
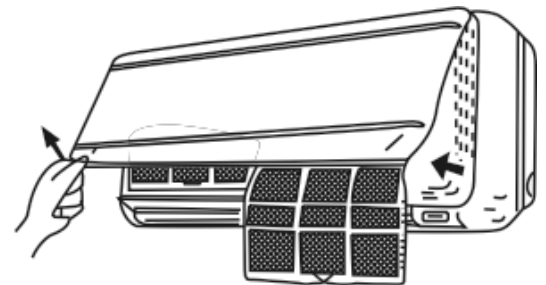

3. Keep the front panel open and reinstall the filter(s). Press the panel shut; a click indicates it is closed properly.
4. Restore the power from the consumer unit and turn the air conditioner on.

INDOOR UNIT: While the unit is disconnected from power dust regularly with a dry cloth or slightly damp paper towel. Never use chemicals or solvents. Never spray a liquid in or over the appliance.

OUTDOOR UNIT: While the unit is disconnected from power. Remove dirt and keep the air intake and exhaust openings free of debris, etc. Cleaning with chemicals may cause damage.

MAINTENANCE

END OF SEASON

If the air conditioner is not going to be used for an extended period:

- Set in fan mode on a slightly warm day so that the inside of the appliance dries out.
- Switch off the power at the fuse box and remove the batteries from the remote control.
- Clean the filters.
- Remove the batteries from the remote control.

START OF SEASON

If the air conditioner is to be used again after an extended period:

- Check that the air intake and exhaust openings of the interior and exterior units are not blocked. Remove any dirt or debris that has accumulated.
- Check that the filter is installed within the indoor unit and is clean.
- Check that the condensation outlet drains properly and there is no dirt or organic blockage (otherwise leakage may occur)
- Install 2 AAA batteries in the remote control.
- Turn the appliance on, set the time and desired setting.

REPLACING THE BATTERIES

- Remove the cover from the rear of the remote control.
- Replace the AAA batteries, ensuring the correct polarity.
- Reinstall the cover on the rear of the remote control.
- If nothing is displayed on the remote, try pressing the power button. If still no response, check the polarity of the batteries and try replacing.

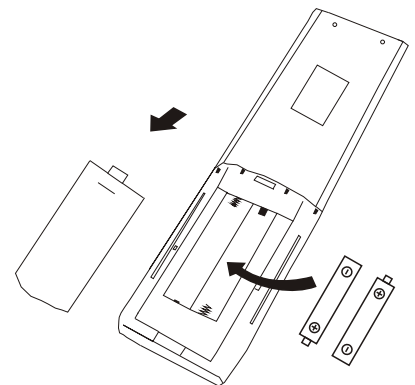

INSTALLATION GUIDE

SAFETY

- Only qualified personnel should install this appliance. This installation manual is intended for use by individuals possessing adequate backgrounds and qualifications in electrical, electronic, refrigerant and mechanical fields. Any attempt to install or repair the appliance may result in personal injury and property damage.
- The manufacturer and retailer cannot be responsible for the interpretation of this information, nor can it assume any liability in connection with its use.
- The units are designed for permanent installation.
- The equipment is designed for domestic or office use and we are not making any endorsements for use in industrial or maritime environment.
- Do not place near sources of heat, vapors, industrial machine oil or other flammable gases.
- High-frequency waves generated by radio equipment, welders and medical equipment will interfere with the normal operation of the unit.
- Install this device only when it complies with local/national legislation, ordinances and standards.
- Check the mains voltage and frequency. This unit is only suitable for an earthed electrical supply, connection voltage 230 V~ / 50 Hz. The information, specifications and parameter are subject to change due to technical modifications or improvement without any prior notice. The accurate specifications are presented on the nameplate label.
- Please read this installation manual completely before installing the product.
- When the power cord is damaged, replacement work shall be performed by authorized personnel only.
- Installation work must be performed in accordance with all European, national and / or local directives and standards and must be done by authorized personnel only.
- Always make sure to wear the correct personal safety protections such as protective eyewear, gloves, ear protection etc.
- This air conditioner contains a refrigerant and can be classified as pressurized equipment. Therefore always contact an authorized air conditioning engineer for installation and maintenance of the air conditioner.
- The air conditioner must be inspected and serviced on an annual basis by an authorised air conditioning engineer.

INSTALLATION GUIDE

INDOOR UNIT POSITION

The air inlet and outlet vent should be away from any obstruction, ensuring that there is a good airflow through the whole air-conditioned space. Select a position where the condensing water can be easily drained out, and the indoor unit can be easily connected to outdoor unit. The wall where the unit is fixed should be strong enough to withstand the full weight and vibration of the unit. The unit should be accessible for service and maintenance. The height of the installed unit should be ideally more than 200cm from the floor. The air conditioner must not be installed in a wet environment such as a bathroom, shower or swimming pool etc.

OUTDOOR UNIT POSITION

A convenient position, dry and well ventilated, outside of direct sunlight or strong winds, which is not on a flood line and where noise and airflow does not cause interference or inconvenience. Select a location where there are no obstructions to the inlet and outlet vents. The location should be able to withstand the full weight and vibration of the outdoor unit and permit safe installation.

Make sure that the outdoor unit is installed in compliance with the installation dimension diagram with easy maintenance access. Select a place where it is out of reach of children. Do not block utilities access or fire escapes.

The external unit must be lifted and put in place by two people.

NOTES:

1. Only use a power supply with the correct ratings, making sure the correct sized power cables are used
2. The appliance shall be installed in accordance with standard wiring regulations by qualified personnel
3. Only replace fuses according to their printed rating or corresponding pcb boards.

INSTALLATION GUIDE

RECOMMENDED INSTALLATION SPACING DIAGRAM

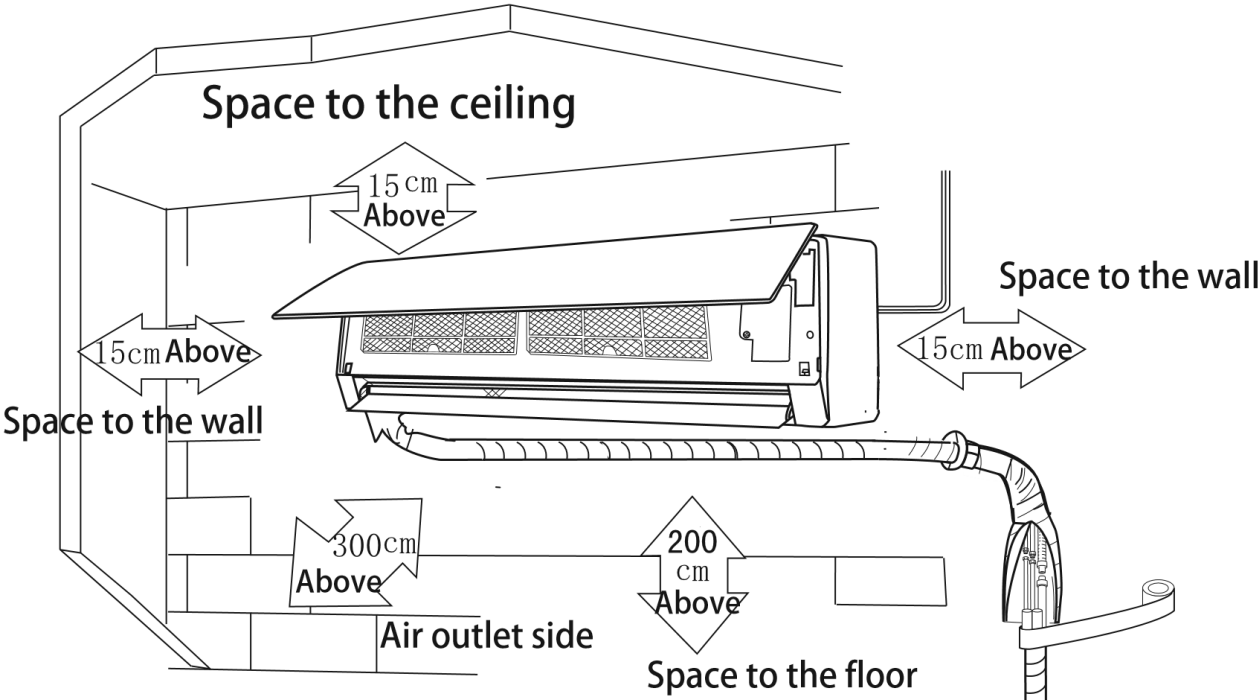

- The dimensions of the space necessary for correct installation of the appliance including the minimum permissible distances to adjacent structures

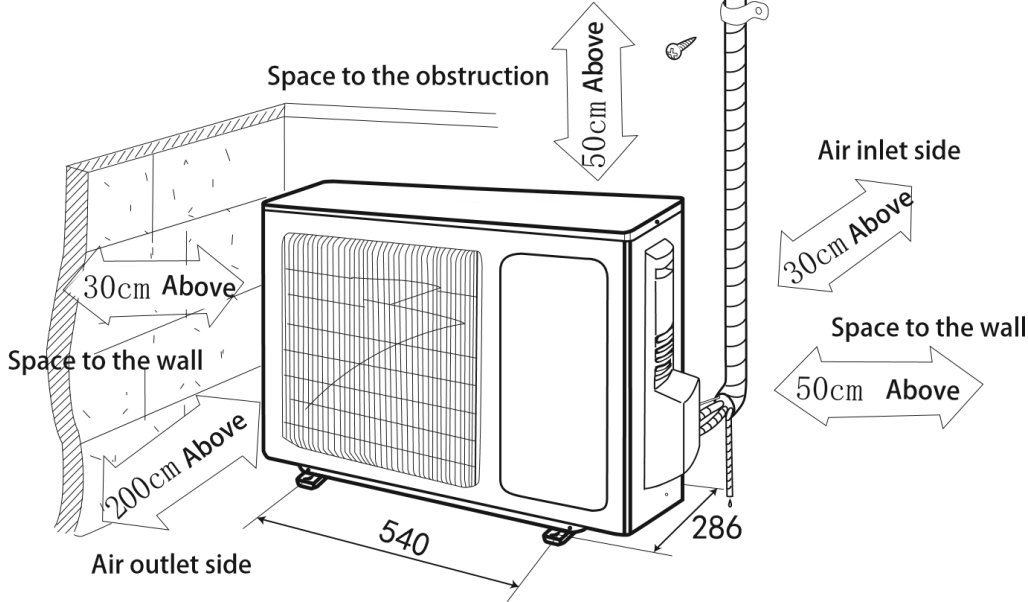

INSTALLATION GUIDE

TOOLS RECOMMENDED FOR INSTALLATION



Electric Drill



Hammer



Screwdrivers



Tape Measure



Core Hole Cutter



Spirit Level



Number 14 (7mm)
Masonry Drill

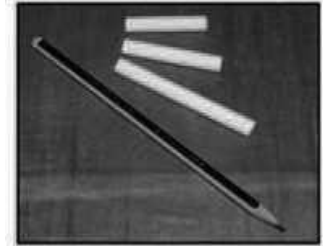

Pencil and Chalk



1.5 inch number
10 screws



Small Stepladder



7mm Wall Plugs



Protective Glasses
and Mask



Pipe and Cable
Detector

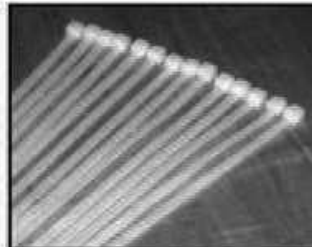

4 inch Plastic Ties



2 Inch Pipe Clips



Circuit Breaker



Garden Gloves
(For Handling
Outdoor Unit)



Dust Sheets



Foam Filler



Silicone Sealant
and gun

INSTALLATION GUIDE



1. Check the area for any hidden wires or pipes.



2. Mark the right hand backplate screw position.



3. Remove the backplate and drill a 7mm hole.

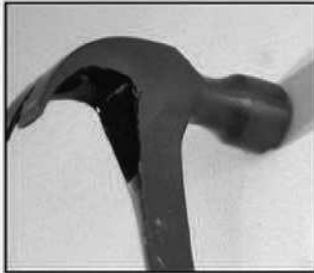

4. Tap a 7mm wall plug into position.

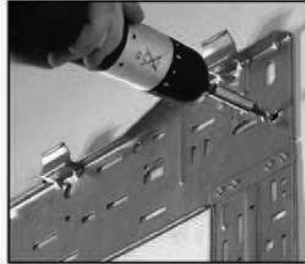

5. Screw the backplate to the wall using 1.5 inch number 10 screws.



6. Check to ensure level, then mark the other holes and swing the backplate away.



7. Drill the rest of the holes and insert the wall plugs.

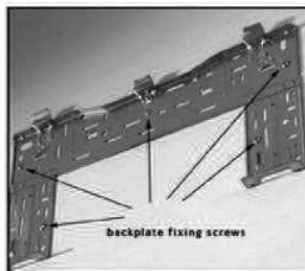

8. Fix the backplate to the wall.

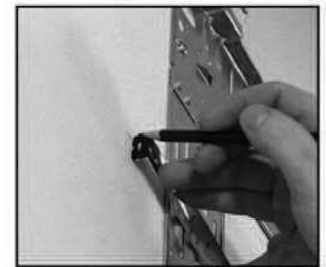

9. Mark the hole centre and make sure the cutter will clear the backplate.



10. Drill the hole at a slight downwards angle. When you feel the pilot drill exit the outside wall stop.



11. Finish the hole from the outside to keep it clean.



12. Feed the cord and drain hose carefully through the wall.



13. Undo the power lead and break out the plastic tab.

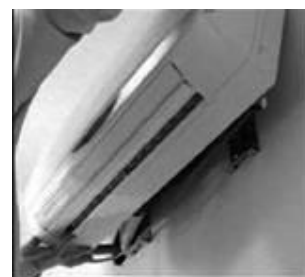

14. Hook the indoor unit onto the top of the backplate.



15. Lock the bottom of the unit onto the base of the backplate.

INSTALLATION GUIDE

INFORMATION REGARDING THE INSTALLATION OF THE INDOOR UNIT

INSTALLING THE REAR PANEL

1. Always mount the rear panel horizontally. Due to the water tray within the indoor unit we would advise that the outlet of the water tray should be fractionally lower when installing as this will aid drainage of the condensate collected.
2. Fix the rear panel on the wall with screws.
3. Be sure that the rear panel has been fixed firmly enough to withstand the weight of an adult (60Kg), furthermore the weight should be evenly shared by each screw.

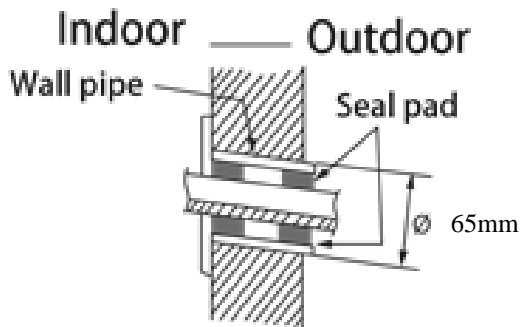
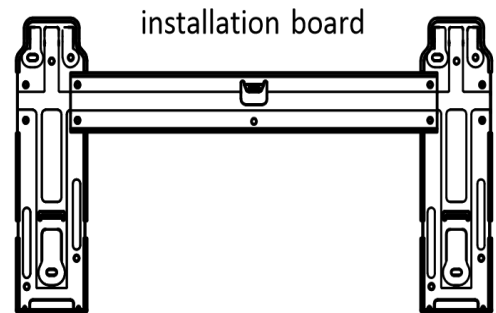

INSTALLING THE PIPING HOLE

1. Make the piping hole (65mm diameter) in the wall at a slight downward slant to the outdoor side (To aid drainage of the condensate).
2. Insert the piping-hole sleeve into the hole to prevent the connecting piping and wiring from being damaged when passing through the hole.

The piping can be lead out on the right, left or directly behind the indoor unit as seen in fig. 1. Please cut off the pipe hole guards if you are changing the pipe position. The unit also features alternative guards for more pipe positioning.

Make sure that the drain pipe is underneath the pipelines. (Fig.3) (When the drain pipe passes the room interior, some condensed water might occur to its surfaces if the humidity is very high).

Tidy up the copper pipes, electrical cables and water drains and pass them through the wall hole drilled earlier (fig.2).

Hang the mounting slots of the indoor unit on the wall mounting bracket making sure is tight in place (fig.3) so that the hooks at the bottom of the indoor unit match the hooks of the wall mounting bracket (fig.4)

INSTALLATION GUIDE

Notes:

1. The height of the installed unit is recommended to be > 200 cm.
2. Either the indoor unit or the outdoor unit can be higher, but the height difference must comply with a max. 5 metres level difference.
3. Try to avoid bending the pipes as much as possible so as to avoid possible negative impacts upon the performances of the unit.

Fig.4

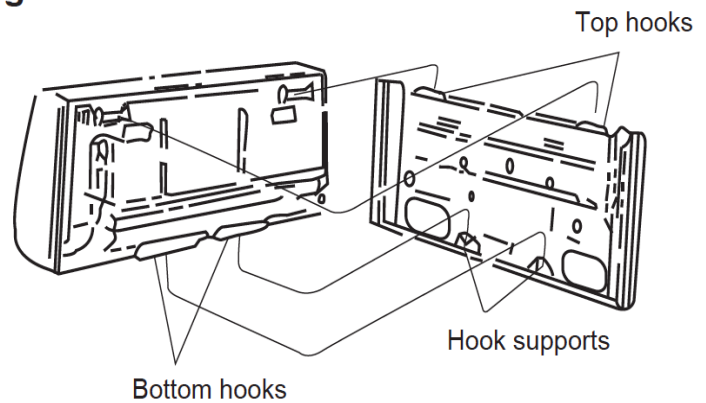

INSTALLATION OF THE OUTDOOR UNIT

Try to move the product to the installation location in its original packaging

As the gravity centre of the unit is not at the installation centre, special caution should be taken when using hoisting cables to lift it up

During transport, the outdoor unit must not be tilted to over 45 degrees (also do not store the unit horizontally).

Use expansion bolts to fix the mounting supports on the wall;

Use bolts and nuts to fix the outdoor unit firmly on the supports and keep on the same level;

If the unit is installed on the wall or at the rooftop, the supports have to be firmly fixed so as to resist earthquakes or strong wind.

Dimensions for parallel units installations

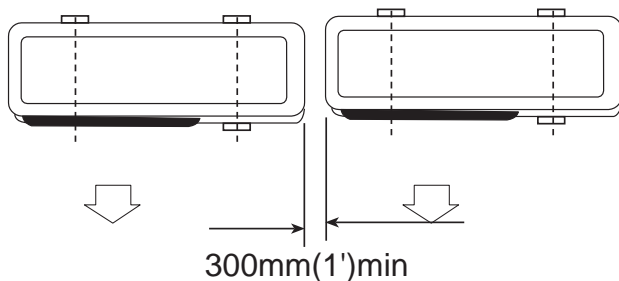

CONDENSATE DRAINAGE OF THE OUTDOOR UNIT

When operating in heating mode condensate will collect and drain through the base of the outdoor unit. The air conditioner is supplied with an elbow joint which can be connected to the underside of the outdoor unit for drainage.

1. Connect the elbow joint to the drainage hole on the underside of the outdoor unit.
2. Connect a drain hose (not supplied) to the elbow joint and run downhill to your chosen drainage point.

Please note: The drainage is gravity fed, and so must run downhill.

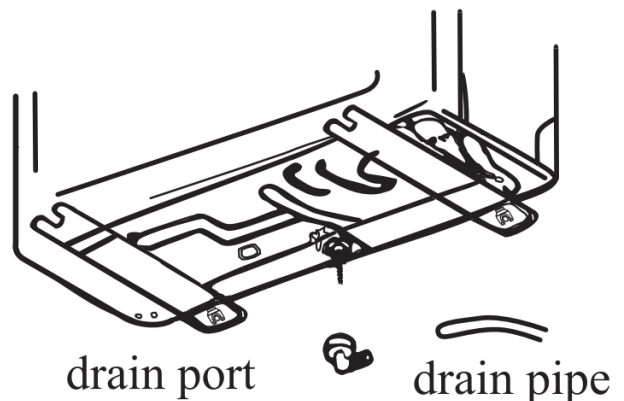

INSTALLATION GUIDE

STANDARD PIPELINES CONNECTION & AIR PURGING

No dust or any other particles, air or moisture should be allowed to enter the air conditioning system. Careful attention should be paid when pipeline connection for outdoor unit is made. Try to avoid repeated curves as much as possible; otherwise damage to the copper pipes may occur. Suitable wrenches should be used when the pipeline connection is done so as to ensure appropriate torque (refer to following torque table). Excessive torque action might damage the joints while too little torque might lead to leakage.

Torque based upon the wrench to be used

Copper pipe diam.	Tightening torque (N.m)
6.35(1/4")	15 - 20
9.52(3/8")	35 - 40
12.7(1/2")	50 - 55
15.88(5/8")	60 - 75

AIR PURGING WITH VACUUM PUMP

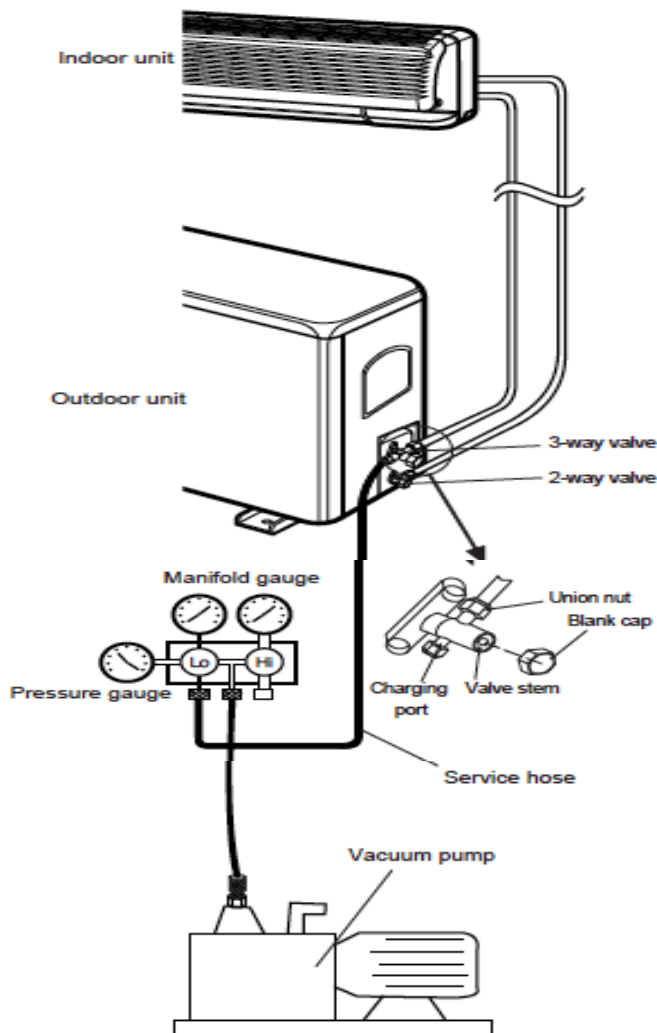

Fig.6

1. Check that pipelines connection have been properly connected, remove the charging port cap, and connect the manifold gauge and the vacuum pump to the charging valve by service hoses as shown
2. Open the valve of the low-pressure side of manifold gauge, then run the vacuum pump. Vacuum the indoor unit and the connecting pipes until the pressure in them lowers to below 1.5mmHG (The operation time for vacuuming is about 10 minutes). When the desired vacuum is reached, close the valve of the low pressure of the manifold and stop the vacuum pump.
3. Disconnect the service hoses and fit the cap to the charging valve.
4. Remove the blank caps, and fully opens the spindles of the 2-way and 3-ways valves with a service valve wrench.
5. Tighten the blanking caps of the 2-way and 3-ways valves, applying the above torque Table

INSTALLATION GUIDE

ADDING REFRIGERANT

Refrigerant must be added if the pipe length is more than 5 metres (16'5"). This operation can only be performed by a professional F-Gas engineer, for the additional gas amount, see the below

Tubing size(mm/inch)		Standard tubing Length (m)	Max tubing Length (m)	Height Difference (m)	Additional refrigerants(g/.m)
Liquid tube	Gas tube				
φ 6(1/4")	φ 9.52(3/8")	5.0	9	5	12
φ 6(1/4")	φ 12(1/2")	5.0	12	7	12
φ 6(1/4")	φ 15.88(5/8")	5.0	15	8	12
φ 9.52(3/8")	φ 15.88(5/8")	5.0	15	8	15
φ 9.52(3/8")	φ 19.05(3/4")	5.0	20	10	15

GAS LEAKAGE INSPECTION

After the pipeline connection is done, use a leakage inspection device to carefully check if there is any leakage at the joints. This is an important step to ensure the quality of installation. Once a leak is detected, proper action should be taken immediately.

INSTALL THE WATER DRAINAGE PIPE



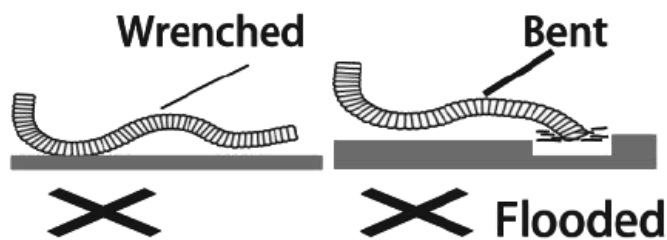



1. For good drainage, the drain hose should be angled downwards.
2. Do not pull on or bend the drain hose or flood its end with water.
3. When the long drainage hose passes through indoor areas, it should be wrapped in insulation.

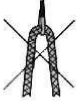
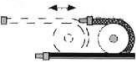
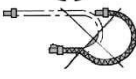

INSTALLATION GUIDE

NOTES:

The copper pipe used in the refrigeration lines are very soft, high pressure copper and prone to get damaged if not handled correctly. Try to avoid bending or stretching the pipework. Always ensure the pipes are protected when running through the wall to help prevent damage to the pipes.

<p>To keep the allowed bending radius please make the packed soft pipes vertical before extending</p>			<p>Please do not extend only one side of the packed soft pipes.</p>
<p>Please make use of semicircle pulley to keep the allowed bending angle</p>			<p>Extreme bending could damage the pipes</p>
<p>Please use a twisting wheel to avoid improper bending.</p>			<p>Over bent soft pipes will lead to irregular bending</p>
<p>Please use rigid elbow to keep the bending angle while soft pipes operating.</p>			<p>Undersize bending will damage the soft pipe.</p>
<p>Please keep the minimum bending angle while installing</p>			<p>Do not use short sharp angle bends.</p>

ELECTRICAL WIRING DIAGRAMS

ELECTRICAL CONNECTION OF THE AIR CONDITIONER

- The electrical connections can be found under the protective plastic cover. Remove this from the side of the outdoor unit to gain access to the electrical connections.
- Connect the indoor power and control wires with the matching outdoor wire as per the electrical diagram.
- Do not attempt to connect the wires in a different way to the diagram on the air conditioner as this could damage the unit and invalidate the warranty.
- Secure the wires and replace the cover before operating the unit.
- The appliance should be installed in accordance with national wiring regulations.
- If the supply cord is damaged, it must be replaced by the manufacturer, its service agent or a suitably qualified person in order to avoid a hazard.
- The air conditioner electrical wiring must follow the specific country regulations. If power cord is damaged must be replace by a qualified electrician.

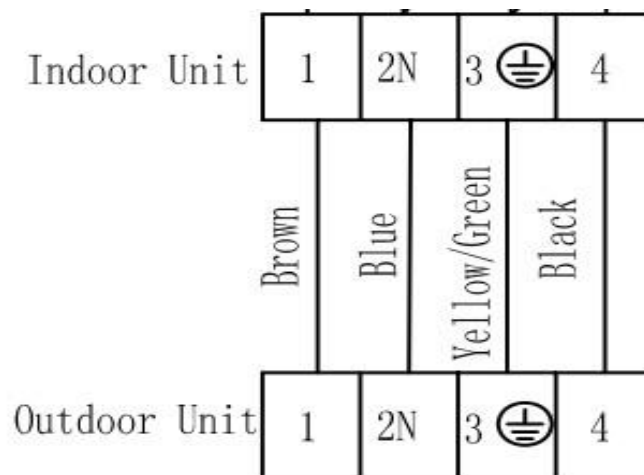

TROUBLESHOOTING AND SELF DIAGNOSIS

MALFUNCTION	POSSIBLE CAUSE
The appliance does not operate	Power failure
	Damaged indoor/outdoor unit fan motor
	Faulty compressor thermomagnetic circuit breaker
	Faulty protective device or fuses
	Loose connections
	Self protection in adverse conditions
	Voltage higher / lower than the voltage range
	Active TIMER-ON function
	Damaged electronic control board
Strange odour	Air filter dirty
Noise of running water	Back flow of liquid in the refrigerant circulation
A fine mist comes from the air outlet	This occurs when the air in the room becomes very cold, for example in the COOLING or DEHUMIDIFYING modes.
A strange noise can be heard	This noise is made by the expansion or contraction of the front panel due to variations in temperature and does not indicate a problem.
Insufficient airflow, either hot or cold	Inappropriate temperature setting.
	Air inlet or outlet of indoor or outdoor unit has been blocked.
	Air filter is blocked.
	Fan speed set at minimum.
	Other sources of heat in the room.
	No refrigerant.
The appliance does not respond to commands	Remote control is not near enough to indoor unit.
	Battery in Remote controller may have been exhausted..
	Obstacles between remote control and signal receiver in indoor unit.
The display is off	Active LED function
	Power failure
Remote cannot select heating mode.	Remove the batteries from the remote and follow the guide for setting up the remote.
Switch off the air conditioner immediately and cut off the power supply in the event of:	
Strange noises during operation.	
Faulty electronic control board	
Faulty fuses or switches.	
Spraying water or objects inside the appliance.	
Overheated cables.	
Very strong smells coming from the appliance.	

TROUBLESHOOTING AND SELF DIAGNOSIS

ERROR SIGNALS ON THE DISPLAY	
In case of error, the display on the indoor unit shown the following error codes:	
ERROR CODE	FAILURE TYPE
EE	Indoor unit EEPROM fault
F0	Indoor fan motor fault
E1	Indoor PCB Zero crossing fault
F3	Indoor coil sensor fault
F1	Indoor room temperature sensor fault
F6	Indoor and outdoor communication fault
EF	Outdoor unit EEPROM fault
E4	Compressor starting abnormal (Phase failure reverse)
E3	Compressor out of step fault
F9	IPM module fault intelligent power module
F5	Exhaust temperature sensor fault
F4	Outdoor coil temperature sensor fault
F2	Outdoor ambient temperature sensor fault
E2	Outdoor DC fan motor fault
Protection Display Code List	
PE	Heating outdoor ambient temperature over-high protection
P4	Heating indoor coil overheat protection
P5	Cooling indoor coil anti-freezing protection
P9	IPM over-high temperature protection
P7	Outdoor unit over-high/over-low AC voltage protection

TROUBLESHOOTING AND SELF DIAGNOSIS

OUTDOOR UNIT FAULT CODES

The outdoor unit has an LED on the power board. This LED will be illuminated when the compressor is running and blink 1s on and 1s off when the compressor is in standby. If there is a fault on the outdoor unit, it will blink on and off for half a second at a time, followed by a 3s gap. The number of consecutive blinks will show the fault as per the table below:

No. of flashes	Fault
2	Indoor and outdoor communication fault
3	Main board and driver board communication fault
4	Compressor starting abnormal (phase failure, reverse)
5	Compressor out-of-step fault
6	IPM module fault
7	Compressor shell roof fault/protection
8	Exhaust temperature sensor fault
9	Suction temperature sensor fault
10	Outdoor coil temperature sensor fault
11	Outdoor ambient temperature sensor fault
12	Outdoor DC fan motor fault
13	Outdoor AC current protection
14	Compressor phase current protection
15	Outdoor unit over-high/over-low AC voltage protection
16	Outdoor unit over-high/over-low DC voltage protection
17	IPM over-high temperature protection
18	Exhaust temperature overheat protection
19	Cooling indoor coil anti-freezing protection
20	Cooling outdoor coil overheat protection shutdown
21	Heating indoor coil overheat protection
22	Cooling outdoor ambient temperature over-low protection
23	Heating outdoor ambient temperature over-high protection

TROUBLESHOOTING AND SELF DIAGNOSIS

Description	Possible Cause
Air conditioner can't be configured successfully	<ol style="list-style-type: none"> 1. Check the mobile device is connected to WiFi 2. Check the AC is connected 3. Check that any firewall or other restrictions are causing problems 4. Check the router is functioning normally 5. Check that the router isn't blocking the App
Mobile device can't control the air conditioner	<p>The app displays "Identification failed". This indicates that the AC has been reset and the mobile device has lost contact with the AC. Reconnect the device following the above instructions. If this fails, delete the AC from your devices list and start the install process from the beginning.</p>
Mobile device can't find AC	<p>The app displays "Air conditioner offline". Check the below:</p> <ol style="list-style-type: none"> 1. The AC has been reconfigured 2. The AC is not receiving power 3. The router is not powered on 4. The AC can't connect to router 5. The AC can't connect to network through the router 6. The mobile device can't connect to the router 7. The mobile device can't connect to a network (when being used remotely)

APPENDIX

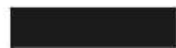

Disposal: Do not dispose this product as unsorted municipal waste. Collection of such waste must be handled separately as special treatment is necessary.

Recycling facilities are now available for all customers at which you can deposit your old electrical products. Customers will be able to take any old electrical equipment to participating sites run by their local councils. Please remember that this equipment will be further handled during the recycling process, so please be considerate when depositing your equipment. Please contact the local council for details of your local household waste recycling centres.

TECHNICAL SPECIFICATION

Model		iQool9PLUS-V2		iQool12PLUS-V2	
Rated voltage and frequency (Ph-V-Hz)		1Ph/220-240V~/50Hz		1Ph/220-240V~/50Hz	
Fuse Required		13A		13A	
Mode		Cooling	Heating	Cooling	Heating
Rated capacity (W)		2600 (660~3300)	2600 (660~3600)	3500 (660~3800)	3500 (660~4000)
Power input (W)		580 (250~1300)	620 (250~1300)	950 (250~1600)	920 (250~165)
Current input (A)		2.7 (1.1~8.8)	2.9 (1.1~9.0)	4.4 (1.1~9.6)	4.3 (1.1~10.0)
SEER/SCOP(W/W)		8.7/A+++	4.6/A++	8.5/A+++	4.6/A++
Nominal load (kW)		1.3	1.3	1.6	1.6
Balance point temperature heating (°C)		/	-7	/	-7
Min. outdoor operating temperature (°C)		/	-15	/	-15
Thermostat-off mode (W)		25		25	
Standby mode (W)		0.5		0.5	
Off mode (W)		0		0	
Annual consumption (kW)		96	670	130	770
Copper Pipe Type length		5m		5m	
Liquid side / Gas side (mm/inch)		6.35 (1/4) + 9.52 (3/8)		6.35 (1/4) + 9.52 (3/8)	
Max. refrigerant pipe length		9m		9m	
Max. elevation		5m		5m	
Interconnecting Cable		4x1.0mm ²		4x1.0mm ²	
Fuse Rating		4A on indoor PCB		4A on indoor PCB	
Moisture Removal (L/h)		1.0		1.2	
Built In Ioniser		No		No	
Indoor	Air Flow (m ³ /h)	550		600	
	Dimensions (W*D*H) (mm)	805 x 270 x 197		805 x 270 x 197	
	Packaging (W*D*H) (mm)	898 x 273 x 328		898 x 273 x 328	
	Net / Gross weight (Kg)	7.5 / 9		7.5 / 9	
	Noise – Sound pressure level (dB/A)	36~42		36~42	
	Noise – Sound power level (dB/A)	37~52		37~52	
Outdoor	Dimension (W*D*H) (mm)	780 x 560 x 270		780 x 560 x 270	
	Packaging (W*D*H) (mm)	889 x 612 x 359		889 x 612 x 359	
	Net / Gross Weight (Kg)	25.3 / 29.5		25.3 / 29.5	
	Noise – Sound pressure level (dB/A)	54		54	
	Noise – Sound power level (dB/A)	65		65	
	Refrigerant type/weight	R32/600g		R32/620g	
	Defrost mode	Automatic defrosting		Automatic defrosting	
	Applicable climate types	Cooling (15°C – 53°C) Heating (-15°C – 30°C)		Cooling (15°C – 53°C) Heating (-15°C – 30°C)	



Consult the manufacturer's manual for safe use of R32

Due to continuous product development process specification may change. These units contain a gas governed by F-Gas regulations. The gas must be handled by qualified F-Gas engineers.

SUPPORT

WARRANTY INFORMATION

electriQ guarantee provides cover against material or manufacturing faults. This means that if your air conditioner develops a fault during the guarantee period, we will arrange for it to be repaired or replaced.

Faults arising from a faulty installation are specifically excluded.

The system must be serviced annually by qualified personnel.

This unit must be operated under conditions as recommended in this user manual, at voltages indicated on the unit. Any attempts made to service or modify the unit by unqualified person, will render this WARRANTY VOID.

This warranty is in addition to, and does not affect, your statutory rights.

We recommend that you note the details of your purchase below and retain your original proof of purchase receipt with this manual. Keep these documents safe in the event of a warranty claim.

Purchase Date: _____

Retailer name: _____

Model number: _____

Serial number: _____

Installation Date: _____

Installer name: _____

Service Date: _____

Engineer/ Company name: _____

electriQ UK SUPPORT

www.electriQ.co.uk/support

Please, for your own convenience, check the troubleshooting guide before calling the service line.

If the unit still fails to operate call: 0330 390 3061 or complete the online form

Office hours: 9AM - 5PM Monday to Friday

www.electriQ.co.uk

Unit J6, Lowfields Way

Elland, West Yorkshire

HX5 9DA